

- NOTES :
1. Material : C1720 1/2H 0.10 T
  2. The tolerance is  $\pm 0.2$  mm
  3. Dimension : 2.0(W)X4.0(L)X3.7(H)
  4. Plated : Au Plated

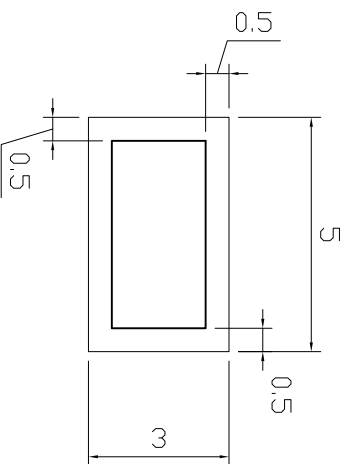

PCB Layout Recommendation

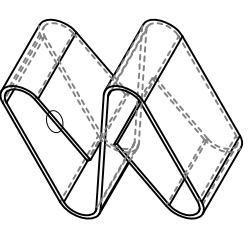
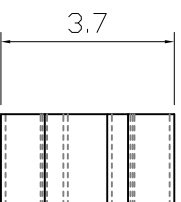
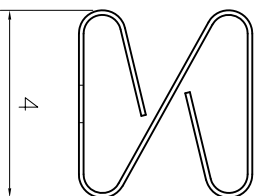
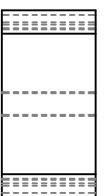

3D View

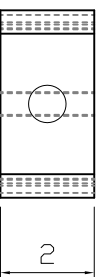
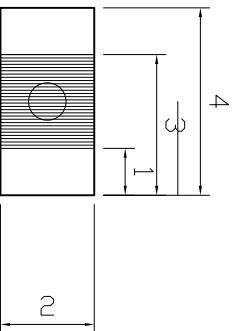

SOLDER PAD DIMENSION

\*\*\* This file contains confidential information intended for a specific individual and purpose, and is protected by law, if you are not the intended recipient, you shouldn't own this file and are hereby notified that any disclosure, copy, or distribution of this data, or the talking of any action based on it, are strictly prohibited.

APPD:	QTY:	ALINK P/N:	8G2040037B
DR:	SCALE:	Customer P/N :	
	1 : 1		
CHKD:	REV:	Customer :	
	A1		
	UNIT:		
	mm		
Draw by:	MAT'L:	Plater:	
	C1720 1/2H 0.10 T	Au Plated	

