



www.sunelec.co.jp

Capacitors General Catalog

ELECTROLYTIC
CAPACITORS



Capacitors General Catalog

Aluminum Electrolytic Capacitors with
Hybrid Conductive Polymer

EP-cap

Aluminum Electrolytic Capacitors

PRECAUTIONS

- The contents of this catalog are current as of December 2022. They may change without prior notice. When ordering products, please be sure to request specifications and carefully to follow instruction.
- Products described herein are not intended for applications requiring extremely high reliability (for example, those in which extensive human injury or property damage may occur such as with lifesupport systems or aircraft control systems). For such applications, consult our sales department.
- The performance, characteristics, and features of the products described in this catalog are based on the products working alone under prescribed conditions. Data listed here is not intended as a guarantee of performance when working as part of any other product or device. In order to detect problems and situations that cannot be predicted beforehand by evaluation of supplied data, please always perform necessary performance evaluations with these devices as part of the product that they will be used in.
- When using the products listed in this catalog, please always be sure to try to prevent any possible accidents or injury by designing products in a careful and safe manner. If you have any questions concerning the use of these products, please contact any of our sales representatives.
- For any products listed in this catalog that may constitute restricted trade goods under overseas exchange or service trade laws, permission to deliver according to law may be required before importing.
- Unauthorized duplication of this catalog in part or in whole is forbidden.
- Please understand that we cannot be held responsible for any damages to the industrial properties of any third party that arise from the use or application of the products listed in this catalog, with the exception of those items directly related to method of construction.

ISO Certificates

IATF 16949

Masuda Plant · Headquarter
Certificate Number IATF 16949-0066829-001
Izumo Plant · Headquarter
Certificate Number IATF 16949-0066829-002
SUN Electronic (Nantong) Co.,Ltd.
Certificate Number 10151345

ISO 9001

Izumo Plant · Masuda Plant · Headquarter Certificate Number ISO 9001-0066829-501
SUN Electronic (Nantong) Co., Ltd. Certificate Number 10151343

ISO 14001

Izumo Plant · Masuda Plant Certificate Number E0792
SUN Electronic (Nantong) Co., Ltd. Certificate Number O1220E20842R5M

INDEX

About SUNCON capacitors

Series Line-up	2
Series Chart	4
Guidelines and Precautions for Use	5
Conforming to environment / Intellectual Property Rights / Surface Mount Type Recommended Land Pattern	9
Soldering Condition / Reflow Soldering Condition	10
Packaging Specifications	11
Ripple Current Frequency Coefficient	14

CA type Anti-vibration Structure

HA Type • HC Type • FA Type • FC Type Anti-vibration Structure	15
---	----

Aluminum Electrolytic Capacitors with Hybrid Conductive Polymer **EP-cap**

Aluminum Electrolytic Capacitors	38
--	----

Series Line-up

Hybrid Conductive Polymer Type **EP-cap**

Classification	Series	Page	Features	High Cap.	Low ESR	Long Life	Solvent Proof	AEC-Q200	Category Temperature Range (°C)	Rated Voltage Range (V.DC)	Rated Capacitance Range (μF)	External Appearance	Marking Color
Surface Mount Type	F V L	19	105°C, 125°C		●		●	●	-55 to +125	6.3 to 10	100 to 1000	—	Blue
	HVHZ/ H V H	20	105°C Long Life		●	●	●	●	-55 to +105	16 to 125	6.8 to 560	—	Blue
	HVPZ/ H V P	21	125°C		●		●	●	-55 to +125	16 to 125	6.8 to 560	—	Blue
	H V T	22	135°C		●		●	●	-55 to +135	25 to 63	10 to 330	—	Blue
	H V J	★	150°C		●		●	●	-55 to +150	25 to 63	15 to 68	—	Blue
	H V H F	23	105°C High Capacitance	●	●	●	●	●	-55 to +105	25 to 100	10 to 470	—	Blue
	H V P F	24	125°C High Capacitance	●	●		●	●	-55 to +125	25 to 100	10 to 470	—	Blue
	H V P X	25	125°C High Ripple	●	●		●	●	-55 to +125	25 to 80	22 to 470	—	Blue
	H V T X	26	135°C High Ripple		●	●	●	●	-55 to +135	25 to 35	47 to 470	—	Blue
	H V H Y	27	105°C High Ripple		●	●	●	●	-55 to +105	25 to 35	150 to 470	—	Blue
	H V P Y	28	125°C High Ripple		●		●	●	-55 to +125	25 to 35	270 to 470	—	Blue
	H V T Y	29	135°C High Ripple		●	●	●	●	-55 to +135	25 to 35	270 to 470	—	Blue
	H V H C	30	105°C High Capacitance	●	●		●	●	-55 to +105	25 to 35	56 to 560	—	Blue
	H V P C	31	125°C High Capacitance	●	●		●	●	-55 to +125	25 to 35	33 to 560	—	Blue
	UP GRADE F V C	32	125°C, 135°C High Capacitance	●	●		●	●	-55 to +135	25 to 35	220 to 1000	—	Blue
F V F	33	150°C Long Life, High Ripple		●	●	●	●	-40 to +150	25 to 80	22 to 680	—	Blue	
F V S	34	125°C, -16V Proof		●		●	●	-55 to +125	35	47 to 220	—	Blue	
Radial Lead Type	H E H	★	105°C		●	●	●	●	-55 to +105	50 to 100	10 to 82	—	Blue
	H E H Z	★	105°C Long Life		●	●	●	●	-55 to +105	16 to 35	47 to 560	—	Blue
	H E P Z	★	125°C		●		●	●	-55 to +125	16 to 35	47 to 560	—	Blue
	H E H F	35	105°C High Capacitance	●	●	●	●	●	-55 to +105	25 to 100	10 to 470	—	Blue
	H E P F	36	125°C High Capacitance	●	●		●	●	-55 to +125	25 to 100	10 to 470	—	Blue
H E P C	37	125°C High Capacitance	●	●		●	●	-55 to +125	25 to 35	100 to 560	—	Blue	

Aluminum Electrolytic Type

Classification	Series	Page	Features	Small & Thin type	Low Impedance	Long Life	Solvent Proof	AEC-Q200	Category Temperature Range (°C)	Rated Voltage Range (V.DC)	Rated Capacitance Range (μF)	External Appearance	Marking Color	
Surface Mount Type	C E - LD	39	4.5mm Height, Long Life	●		●	●	●	-40 to +105	6.3 to 50	10 to 100	—	Black ★ 2	
	C E - FSS	40	105°C Small, High Capacitance	●			●	●	-40 to +105	6.3 to 50	4.7 to 220	—	Black	
	C E - F S	41	105°C Standard					●	●	-40 to +105	160 to 400	2.2 to 82	—	Black ★ 2
		42					●	●	-55 to +105	6.3 to 63	0.47 to 12000	—	Black ★ 2	
	C E - A X	43	Low Impedance					●	●	-40 to +105	100	1.0 to 330	—	Black
		44					●	●	-55 to +105	6.3 to 50	4.7 to 6800	—	Black ★ 2	
	C E - Z X	46	Super Low ESR		●		●	●	-55 to +105	6.3 to 50	33 to 1800	—	Black	
	UP GRADE C E - Z C	47	Super Low ESR, Small, High Capacitance	●	●		●	●	-55 to +105	6.3 to 50	47 to 2200	—	Black	
	C E - L X	48	Low Impedance, Long Life		●	●	●	●	-55 to +105	6.3 to 100	4.7 to 12000	—	Black ★ 2	
	C E - G A	50	5.4mm Height, Low Impedance		●		●	●	-55 to +105	6.3 to 63	1.0 to 220	—	Black	
	C E - L S	51	Low Impedance, Long Life		●	●	●	●	-40 to +105	6.3 to 50	10 to 330	—	Black	
	C E - L H	52	Long Life				●	●	●	-40 to +105	6.3 to 50	1.0 to 220	—	Black
		53					●	●	●	-40 to +105	160 to 400	2.2 to 120	—	Black
	C E - L L	54	Low Impedance, Long Life		●	●	●	●	-40 to +105	6.3 to 50	10 to 1000	—	Black	
	C E - L F	55	Low Impedance, Long Life		●	●	●	●	-40 to +105	16 to 50	100 to 470	—	Black	
	C E - P C	56	125°C				●	●	-55 to +125	6.3 to 100	2.2 to 4700	—	Black	
	UP GRADE C E - P H	58	125°C Low ESR, High Capacitance		●		●	●	-40 to +125	16 to 63	10 to 3900	—	Black	
C E - P S	60	125°C High Capacitance	●			●	●	-40 to +125	16 to 35	47 to 680	—	Black		
C E - P F	61	125°C Long Life, High Ripple				●	●	-40 to +125	25 to 35	100 to 330	—	Black		
C E - T H	62	135°C			●	●	●	-40 to +135	16 to 50	22 to 1000	—	Black		
C E - J X	63	150°C				●	●	-40 to +150	25 to 35	100 to 470	—	Black		
C E - F N	64	105°C Bi-polar				●	●	-55 to +105	6.3 to 63	1.0 to 47	—	Black		

★ 2 Some of specified case sizes' parts will be discontinued. (4×4.5, 5×4.5, 10×7.7)

Please refer to <http://www.sunelec.co.jp> for the information where ★ marking is indicated.

Series Line-up

Aluminum Electrolytic Type

Classification	Series	Page	Features	Small & Thin type	Low Impedance	Long Life	Solvent Proof	Category Temperature Range(°C)	Rated Voltage Range(V.DC)	Rated Capacitance Range(μF)	External Appearance	Marking Color	
Radial Lead Type 	ME-SZ	66	7mm Height, Temperature of Wide Range	●			●	-55 to +105	6.3 to 50	1.0 to 330	Green	White	
	ME-SAX	67	7mm Height, Low Impedance	●	●		●	-55 to +105	6.3 to 35	4.7 to 330	Green	Gold	
	ME-SWG	68	7mm Height, Low ESR	●	●			-40 to +105	6.3 to 35	22 to 330	Black	Gold	
	ME-LS	69	Long Life, High Reliability			●	●	-40 to +105	6.3 to 50	1.0 to 1000	Black	Silver	
	ME-CZ	70	Small Standard, Temperature of Wide Range	●			●	-55 to +105	6.3 to 100	2.2 to 15000	Green	White	
	ME-CA	72	Small Standard, Low Impedance	●	●			-55 to +105	6.3 to 50	2.2 to 15000	Green	Silver	
	ME-CX	74	Small, Low Impedance	●	●		●	-55 to +105	6.3 to 35	47 to 15000	Green	Gold	★2
	ME-AX	76	Low Impedance, Long Life		●	●	●	-55 to +105 -40 to +105	6.3 to 63 100	4.7 to 12000 5.6 to 470	Green	Gold	★2
	ME-WX	78	Low Impedance, High Ripple		●			-40 to +105	6.3 to 50	22 to 6800	Green	Gold	★2
	ME-WA	80	Low Impedance, High Ripple, Long Life		●	●		-40 to +105	6.3 to 63	82 to 8200	Black	Gold	★2
	ME-WL	82	Low Impedance, Long Life	●	●	●		-40 to +105	6.3 to 100	2.2 to 470	Green	Silver	
	ME-WG	83	Super Low ESR		●			-40 to +105	6.3 to 25	220 to 3300	Green	Gold	★2
	ME-FX	84	Long Life			●	●	-40 to +105	10 to 100	2.2 to 470	Black	White	
	ME-FC	85	Guaranteed 105°C (Mid. & High Voltage)					-40 to +105 -25 to +105	160 to 400 450	0.47 to 220 22 to 47	Black	White	
	ME-FD	85	105°C, Low Profile (Mid. & High Voltage)					-40 to +105 -25 to +105	160 to 400 450	22 to 220 10 to 33	Black	White	
	ME-FH	86	105°C, Long Life (Mid. & High Voltage)			●		-40 to +105 -25 to +105	160 to 400 450	4.7 to 220 6.8 to 68	Black	White	
	ME-SWN	87	7mm Height, Bi-polar	●			●	-40 to +85	6.3 to 50	1.0 to 47	Black	White	
ME-HWN	88	Small, Standard, Bi-polar	●			●	-40 to +85	6.3 to 100	1.0 to 2200	Black	White		

★2 Some of specified case sizes' parts will be discontinued. (8×15, 8×20)

Please contact us for AEC-Q200 requirements.

Standardization Notice

For all new design, please place your orders with the suggested alternative series.

Aluminum Electrolytic Type

Surface Mount Type

Series	Features	alternative series
CE-BD ★2, ★3	4.5mm Height	CE-LD
CE-FD ★2	105°C 4.5mm Height	
CE-BSS	Small, Standard	CE-FSS
CE-BS ★3	Standard	CE-FS
CE-FH	Long Life	CE-LX
CE-KX	Low Impedance	
CE-NP ★1	Bi-polar	CE-FN

Radial Lead Type

Series	Features	alternative series
ME-UW ★1	5mm Height	—
ME-UZ ★1	5mm Height, Temperature of Wide Range	
ME-UAX ★1	5mm Height, Low Impedance	
ME-SWB	7mm Height	ME-SZ
ME-HC	Standard	ME-CZ
ME-FA	105°C Standard	
ME-PX ★1	125°C	—
ME-HPC	Standard(Mid. & High Voltage)	ME-FC(Mid. & High Voltage)
ME-HPD	Long Profile(Mid. & High Voltage)	ME-FD(Mid. & High Voltage)
ME-FAZ ★1	Low Impedance, High Ripple(Mid. & High Voltage)	—
ME-UWN ★1	5mm Height, Bi-polar	—

★1 It will be discontinued.

★2 Some of specified case sizes' parts will be discontinued. (4×4.5, 5×4.5)

★3 Some of specified rated voltage parts will be discontinued. (4V)

Series Chart

Hybrid Conductive Polymer Type *EP-cap*

SURFACE MOUNT TYPE

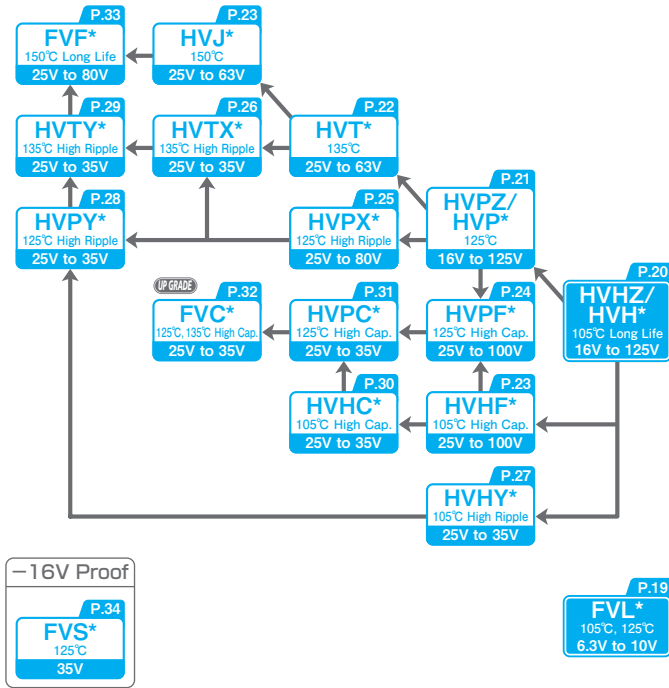

RADIAL LEAD TYPE

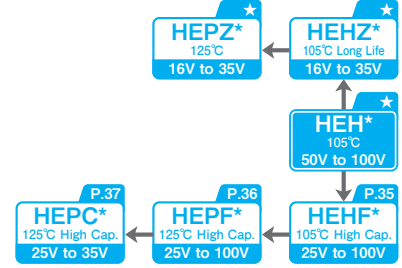

Aluminum Electrolytic Type

SURFACE MOUNT TYPE

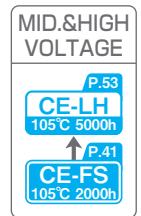
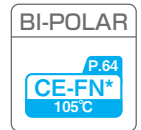
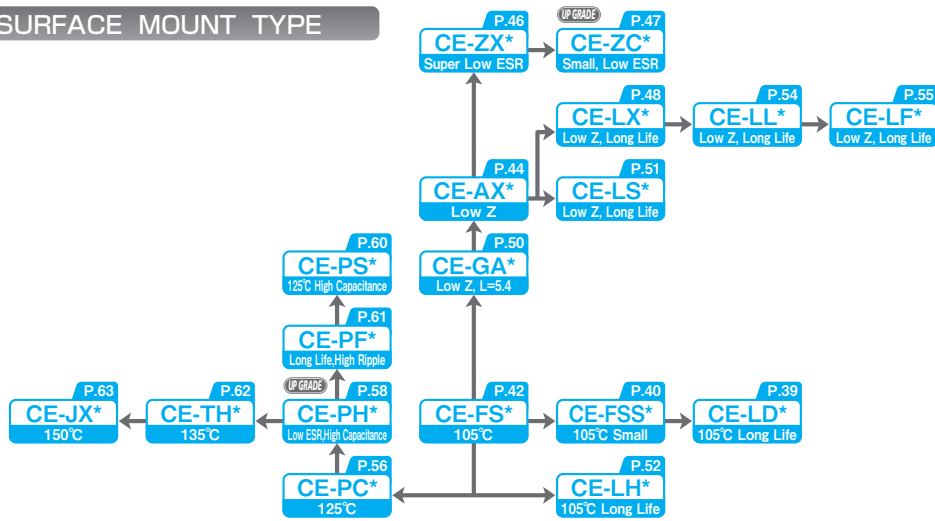

RADIAL LEAD TYPE

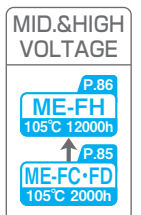
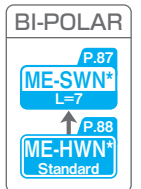
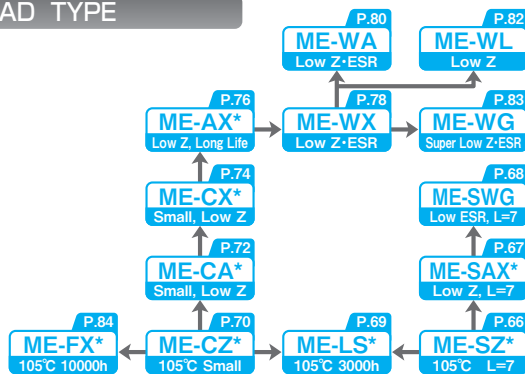

★solvent proof

Please refer to <http://www.sunelec.co.jp> for the information where ★ marking is indicated.

Guidelines and Precautions for Use

For using aluminum electrolytic capacitors (hereafter "capacitor/capacitors"), please pay attention to the guidelines listed below.

For circuit design

- 1) Please make sure that the operating condition and the mounting condition are within the rated value which is described in the catalog or the specification.
- 2) Please make sure that the operating temperature and the operating ripple current are within the rated value which is described in the catalog or the specification.
 - a) The operating temperature affects the lifetime of the capacitor. Generally speaking, the expected lifetime of the capacitor is 2times longer by each 10degC reduction. Please use the capacitor within the upper limit of the category temperature.
 - b) Do not apply an excessive ripple current (higher than the rated ripple current) to the capacitor. An excessive ripple current may cause abnormal heating which leads to a damage or a shortening lifetime of the capacitor. Please use the capacitor within the rated ripple current described in the catalog or the specification.
- 3) Please choose a capacitor which meets the designed lifetime of the application.
- 4) The capacitor has a polarity. Do not apply a reverse voltage or an alternating current voltage to the capacitor. Please use the bi-polar capacitor for the circuit which polarity may change or be unstable. Do not use the bi-polar capacitor in an alternating current circuit.
- 5) Do not use the general-purpose capacitor for the circuit which has a repeat of a rapid charge and discharge. Please contact us if the capacitor is exposed in a repeat of a rapid charge and discharge.
- 6) Do not apply an excessive voltage (higher than the rated voltage) to the capacitor.
- 7) The exterior sleeve of the capacitor is not insulated. Do not place the capacitor where insulation is required. The case of the capacitor is not insulated. Please make sure that the case of the capacitor is insulated from the circuit pattern and the lead-wires.
- 8) Do not use the capacitor in the environments listed below.
 - a) In the environment where the capacitor is exposed in water, salt water, oil or where condensation may occur.
 - b) In the environment where poisonous gas (hydrogen sulfide, sulfurous acid, nitrous acid, chlorine, ammonia, etc) is filled in atmosphere.
 - c) In the environment where ozone, ultra-violet, radiation are irradiated.
 - d) In the environment where the capacitor is exposed in the vibration or physical shock which is severer than the range defined in the catalog or the specification.
- 9) For mounting the capacitor, please follow the guidelines listed below.
 - a) Please make sure that the hole space of the circuit board matches the lead-wire space of the capacitor.
 - b) Please make sure that the space above the pressure relief vent is greater than the value listed below.

Case Diameter	Space
$\phi 6.3$ to $\phi 16$	2mm or more
$\phi 18$	3mm or more
 - c) Please make sure that the circuit wires or the circuit pattern is not located above the pressure relief vent.
 - d) If the distance between the top of the capacitor and the circuit board above the capacitor is shorter than the listed in 9.b, please make a hole in the board in order to relieve a gas from the pressure relief vent.
- 10) Design the circuit pattern so that the sealing rubber will not be placed on it.

Guidelines and Precautions for Use

- 11) Do not place heat-generating devices around the capacitor.
Do not place heat-generating devices on the other side of the capacitor.
- 12) Please refer to "surface mount type recommended land pattern" in the catalog or the specification.
- 13) For circuit design, please follow the guidelines listed below.
 - a) Temperature and/or the frequency of a ripple current affect the electrical characteristics of the capacitor.
Please consider the variation of the electrical characteristics for the circuit design.
 - b) For mounting the capacitor on a double-sided circuit board, do not place the capacitor on excessive holes of the circuit board.
 - c) When the multiple capacitors are connected in parallel, please consider the current balance for the capacitors.
 - d) When the multiple capacitors are connected in series, please put resistors (voltage divider) in parallel to keep the voltage balance for the capacitors.

Mounting

- 1) Do not reuse the capacitor which has been mounted and electrically loaded on the circuit board.
- 2) A transient recovery voltage may occur in the capacitor. In this case, please discharge the capacitor through a 1k ohm resistor.
- 3) A high leakage current may occur after the capacitor stores for a long period.
Please apply voltage to the capacitor through a 1k ohm resistor.
- 4) Please check the rated capacitance and the rated voltage of the capacitor before mounting on the circuit board.
- 5) Please check the polarity of the capacitor before mounting on the circuit board.
- 6) Do not drop the capacitor on the floor. Do not use the capacitor which has been dropped on the floor.
- 7) Do not deform the capacitor.
- 8) Do not apply a force which causes a break of the case of the capacitor.
- 9) Please make sure that the hole space of the circuit board matches the lead-wire space of the capacitor.
- 10) Please adjust the clinch force of an automatic insertion machine in order to avoid excessive stress to the lead-wires of the capacitor.
- 11) Do not apply an excessive impact to the capacitor by the suction nozzle of an automatic insertion machine or a chip moulder also the impacts by a component checker or a centering operation.
- 12) For soldering by a soldering iron, please check the guidelines listed below.
 - a) Please make sure that the soldering condition (temperature and duration) is within the range defined in the catalog or the specification.
 - b) If the hole space of the circuit board does not match the space of the lead-wires of the capacitor, please apply a lead-wire forming before soldering. Do not apply an excessive stress to the capacitor when applying a lead-wire forming.
 - c) Do not reuse the capacitor which has been mounted on a circuit board.
 - d) Do not let the tip of a soldering iron contact on the body of the capacitor.

Guidelines and Precautions for Use

- 13) For flow soldering, please follow the guidelines listed below.
 - a) Do not soak the body of the capacitor in a melted solder. Please make sure that the soldering is performed on the other side of the capacitor.
 - b) Please make sure that the soldering conditions (preheating, solder temperature, soak duration) are within the range defined in the catalog or the specification.
 - c) Do not leave flux on the body of the capacitor.
 - d) Do not let the metallic lead-wires of the other components contact on the capacitor.
- 14) For reflow soldering, please follow the guidelines listed below.
 - a) Please make sure that the soldering conditions (preheating, solder temperature, duration) are within the range defined in the catalog or the specification.
 - b) Do not apply excessive heating to the capacitor when using an infrared heater. The color or/and the material of the capacitor affect the absorption of infrared ray.
 - c) Cracks of the ink (for indicating the cathode polarity) may occur, however the cracks do not affect the reliability of the capacitor.
- 15) Do not apply any mechanical stress listed below to the capacitor after mounting on the circuit board.
 - a) Do not tilt, lean, twist the capacitor.
 - b) Do not use the capacitor as a grip for moving a circuit board manually.
 - c) Do not hit the capacitor. When stacking circuit boards, do not let the capacitor contact a circuit board or the other components.
- 16) For washing a printed circuit board. Do not wash the capacitor with a halogen-containing solvent. The solvent-proof capacitor must be used when washing is required. Please make sure that the washing condition is within the range defined in the catalog or the specification. The capacitor may fail due to a type of washing solvent. Please pay attention to the risks listed below.
 - a) A halogen-containing solvent may cause electrochemical corrosion in the capacitor.
 - b) An alkali-containing solvent may cause corrosion (dissolution) of the aluminum case of the capacitor.
 - c) Xylene may cause degradation of the sealing rubber.
 - d) Acetone may cause a loss of the ink.
 - e) A terpene/petroleum-containing solvents may cause degradation of the sealing rubber.
- 17) For washing the solvent-proof capacitor, please follow the guidelines listed below.
 - a) Please control the conductivity, pH, specific gravity, moisture content, etc of a washing solvent.
 - b) Do not store the capacitor where a washing solvent is vaporized or in an airtight enclosure. Do not dry the capacitor or the circuit board by heat higher than the upper limit of the operating temperature.
- 18) Do not use a glue and/or a coating material including halogen.
- 19) For using a glue and/or a coating material, please follow the guidelines listed below.
 - a) Do not leave flux or a stain between the capacitor and the circuit board.
 - b) Please dry out a washing solvent before using a glue and/or a coating material. Do not cover the sealing rubber of the capacitor by a glue and/or a coating material.
 - c) Please make sure that the thermal curing condition for a glue and/or a coating material is within the rated value which is described in the catalog or the specification.

During use in application

- 1) Do not touch the capacitor.
- 2) Do not make a short-circuit between the lead-wires by a conductive material. Do not expose the capacitor in a liquid/conductive solution.

Guidelines and Precautions for Use

- 3) For mounting the circuit board, please follow the guideline listed below. Do not use the device in the following environmental conditions:
 - a) In the environment where the capacitor is exposed in water or oil.
 - b) In the environment where the capacitor is exposed in direct sunlight.
 - c) In the environment where the capacitor is exposed in ozone, ultraviolet ray, or radiation.
 - d) In the environment where poisonous gas (hydrogen sulfide, sulfurous acid, nitrous acid, chlorine, ammonia, etc) is filled in atmosphere.
 - e) In the environment where the capacitor is exposed in the vibration or physical shock which is severer than the range defined in the catalog or the specification.

Maintenance

- 1) For industrial applications, please perform periodical inspections.
- 2) In periodical inspection, please check the points listed below.
 - a) Appearance (open-vent, a leakage of the electrolyte)
 - b) Electrical characteristics (leakage current, capacitance, dissipation factor, and the other items defined in the catalog or the specification)

In case of a problem

- 1) If the safety-vent of the capacitor is opened and a gas relive from it, please turn off the main power supply of the application or plug off the power code from an outlet.
- 2) A high temperature gas over +100degC may come from the safety-vent of the capacitor. Leave the body from the capacitor. If a gas from the capacitor happen to coming into the eyes, please wash the eyes with water immediately. If a gas from the capacitor happen to coming into the mouth, please gargle the mouth with water immediately. Do not lick the electrolyte of the capacitor. If the electrolyte of the capacitor is touched on the skin, please rinse it out with a soap and water.

Storage conditions

- 1) Do not store the capacitor in high temperatures and/or in high humidity. Please store the capacitor at room temperature between 5 and 35degC in relative humidity below 75%. Please use the capacitor within one year after the shipment.
- 2) Do not store the capacitor in the environment where it is exposed in water, oil, or salt water.
- 3) Do not store in the environment where poisonous gas (hydrogen sulfide, sulfurous acid, nitrous acid, chlorine, ammonia, etc) is filled in atmosphere.
- 4) Do not store in the environment where the capacitor is exposed in ozone, ultraviolet ray, or radiation.

Scrap of capacitors

For scraping the capacitor, please follow the guideline listed below.

- a) Please make a hole in the capacitor or crush the capacitor before burning it.
- b) If not, please ask waste-disposal specialist to take care of them, such as burying in the ground.

AEC-Q200 Compatibility

AEC("Automotive Electronics Council") is an organization for standardizing specifications for reliability testing and qualification. AEC was established by automotive manufacturers and electronic component manufacturers in U.S. Testing data for qualification compliant to AEC-Q200 (reliability testing standard for passive components) is available upon request.

For details, please contact us.

For important notice of using the aluminum electrolytic capacitors, we observe the guidelines of EIAJ RCR-2367C "Safety Application Guide for fixed aluminum electrolytic capacitors for use in electronic equipment". Please read carefully the guideline for details.

■ Conforming to environment

We encourage activities for protecting global environment. All our products are lead-free. The sleeve material is PET or sleeve-less(HEH). Please contact us if details are required.

■ Environmental Products (Compliance of RoHS Directive)

Type code	Surface Mount Type Aluminum Electrolytic Capacitors		Radial Lead Type Aluminum Electrolytic Capacitors	
	CE, HV★ ¹	CE_T	ME	HE_T
Cross section of lead wire (Kind of plating)	($\phi 4$ to $\phi 12.5$) 	($\phi 16, \phi 18$) 		
	Part number (example)	10CE100LX (100 μ F / 10V)	10CE4700LXT (4700 μ F / 10V)	10ME100AX (100 μ F / 10V)
Sleeve	Not used	Not used	PET	Not used
Moisture Sensitivity Level(MSL)★ ²	Not applicable No need dry package	Not applicable No need dry package	Not applicable No need dry package	Not applicable No need dry package

★¹ Sn plating lead-wire for Surface Mount Type : "CE_T", "HV_T"

★² Conforming to IPC/JEDEC J-STD-020

■ Conforming to RoHS

The capacitors do not intentionally contain the banned substances (Cd, Pb, Hg, Cr(VI), PBB, PBDE, DEHP, BBP, DBP, DIBP) listed in "RoHS directive : (EU) 2015/863" and its concentration is less than the threshold values.

■ Conforming to European REACH Regulation.

Our products are "articles without any intended releas" based on RIP3.8TGD published on 26 May 2008. They are not applicable for "Registration" for European REACH Regulation Article 7 (1).

■ Intellectual Property Rights

We proactively work on protecting the intellectual property rights of our products.

Examples of the patents related to our aluminum electrolytic capacitors with hybrid conductive polymer(**EP-cap**).

JP. Pat. No.4911509, JP. Pat. No.4916416, JP. Pat. No.5305569, JP. Pat. No.6442162

US. Pat. No.7497879, US. Pat. No.7859829, US. Pat. No.7872858, US. Pat. 11380493

■ Surface Mount Type Recommended Land Pattern

● Land pattern

(Unit:mm)

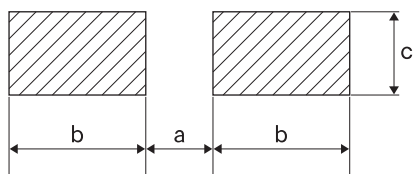

Size	a	b	c
$\phi 4$	1.0	2.6	1.8
$\phi 5$	1.4	3.0	1.8
$\phi 6.3$	1.8	3.6	1.8
$\phi 8$	2.8	4.1	2.1
$\phi 10$	4.3	4.4	2.5
$\phi 12.5$	4.3	5.8	2.5
$\phi 16$	6.6	6.5	5.0
$\phi 18$	6.6	7.7	5.0

(1) Please refer to page 15·16 for S.M.T Recommended Land Pattern of Anti-vibration Structure(CA Type, HA Type, HC Type, FA Type, FC Type).

(2) Please make your land pattern area as large as possible to prevent a large surface mount type from peeling off a circuit board for anti-vibration.

Soldering Condition / Reflow Soldering Condition

Soldering Condition

- Soldering with a soldering iron : within 3 seconds at 350°C unless otherwise specified in the spec.
- Flow soldering : within 10 seconds at 260°C unless otherwise specified in the spec.
(Do not flow soldering with SMD type.)
- Thermal curing oven : within 2 minutes at below 150°C ambient

Reflow Soldering Condition

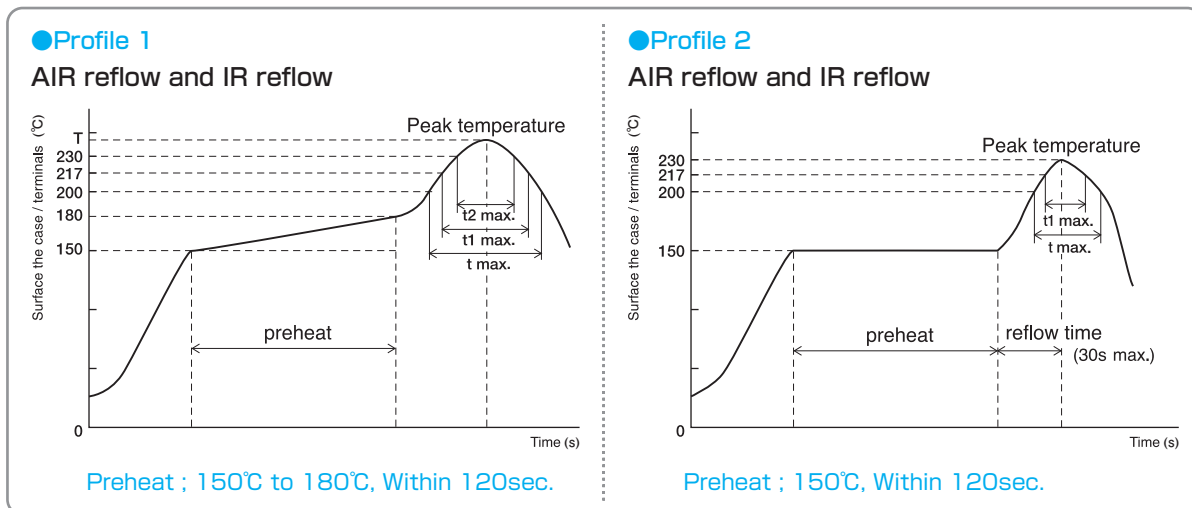

Series	Voltage (V)	Size	Time for more than 200°C (t)	Time for more than 217°C (t1)	Time for more than 230°C (t2)	Peak temperature Within 5sec.(T)	Reflow cycle	Profile
CE-FS, CE-FSS CE-GA, CE-AX CE-LH, CE-LL CE-LF, CE-FN	6.3 to 63	φ4 to φ6.3	Within 70sec.	Within 60sec.	Within 40sec.	250°C	2	1
		φ8	Within 60sec.	Within 50sec.	Within 30sec.	245°C	2	1
		φ10, φ12.5	Within 50sec.	Within 40sec.	Within 20sec.	240°C	2	1
		φ16, φ18	Within 50sec.	Within 30sec.	Within 15sec.	235°C	2	1
	80 to 100	φ4 to φ6.3	Within 60sec.	Within 50sec.	Within 40sec.	250°C	2	1
		φ8	Within 60sec.	Within 40sec.	Within 30sec.	240°C	2	1
		φ10	Within 50sec.	Within 30sec.	Within 20sec.	240°C	2	1
		φ12.5	Within 50sec.	Within 30sec.	Within 20sec.	235°C	2	1
	160 to 400	φ16, φ18	Within 45sec.	Within 20sec.	Within 10sec.	235°C	2	1
		φ8, φ10	Within 50sec.	Within 30sec.	Within 20sec.	240°C	2	1
CE-ZX, CE-ZC CE-LX, CE-LS CE-PC, CE-PH CE-PS, CE-PF CE-TH, CE-JX	6.3 to 50	φ4 to φ8	Within 80sec.	Within 70sec.	Within 40sec.	260°C	2	1
		φ10×10.2 to 13.5	Within 70sec.	Within 60sec.	Within 40sec.	250°C	2	1
		φ12.5	Within 60sec.	Within 50sec.	Within 30sec.	245°C	2	1
		φ10×7.7, φ16, φ18	Within 50sec.	Within 40sec.	Within 20sec.	240°C	2	1
	63	φ6.3	Within 70sec.	Within 60sec.	Within 40sec.	250°C	2	1
		φ8	Within 60sec.	Within 50sec.	Within 30sec.	245°C	2	1
		φ10, φ12.5	Within 50sec.	Within 40sec.	Within 20sec.	240°C	2	1
	80 to 100	φ16, φ18	Within 50sec.	Within 40sec.	Within 15sec.	235°C	2	1
		φ8	Within 60sec.	Within 50sec.	Within 30sec.	240°C	2	1
		φ10	Within 50sec.	Within 40sec.	Within 20sec.	240°C	2	1
		φ12.5	Within 50sec.	Within 40sec.	Within 20sec.	235°C	2	1
		φ16, φ18	Within 45sec.	Within 30sec.	Within 10sec.	235°C	2	1
CE-LD	ALL	ALL	Within 60sec.	Within 50sec.	Within 30sec.	245°C	2	1

The maximum cycle of reflow soldering is two times. The second cycle must be done after sufficient cooling time for more than one hour to return the temperatures of circuit boards and components back to room temperature. Please refer to page 18 for reflow soldering condition of EP-cap.

Packaging Specifications

■ Surface Mount Type Taping Specifications (Unit:mm)

Carrier tape $\phi D \leq 10$

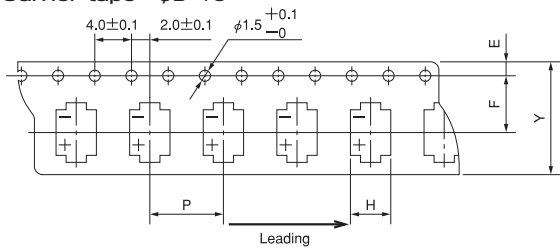

$\phi D \geq 12.5$

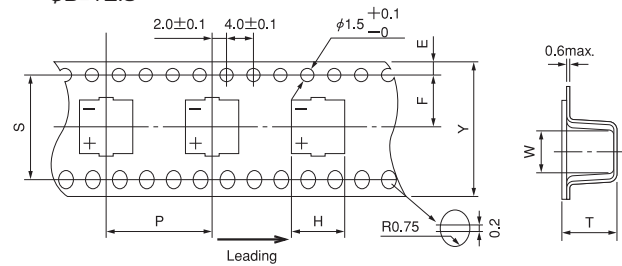

(Unit:mm)

size($\phi D \times L$)	$Y \pm 0.3$	$H \pm 0.2$	$W \pm 0.2$	$P \pm 0.1$	$E \pm 0.1$	$F \pm 0.1$	$T \pm 0.2$	$S \pm 0.1$
$\phi 4 \times 5.4$	12.0	4.7	4.7	8.0	1.75	5.5	5.8	—
$\phi 4 \times 6.0$	12.0	4.7	4.7	8.0	1.75	5.5	6.4	—
$\phi 5 \times 5.4$	12.0	5.7	5.7	12.0	1.75	5.5	5.8	—
$\phi 5 \times 6.0$	12.0	5.7	5.7	12.0	1.75	5.5	6.4	—
$\phi 5 \times 7.0$	12.0	5.7	5.7	12.0	1.75	5.5	7.1	—
$\phi 6.3 \times 4.5$	16.0	7.0	7.0	12.0	1.75	7.5	5.1	—
$\phi 6.3 \times 5.4$	16.0	7.0	7.0	12.0	1.75	7.5	5.8	—
$\phi 6.3 \times 6.0$	16.0	7.0	7.0	12.0	1.75	7.5	6.5	—
$\phi 6.3 \times 7.0$	16.0	7.0	7.0	12.0	1.75	7.5	7.5	—
$\phi 6.3 \times 7.7$	16.0	7.0	7.0	12.0	1.75	7.5	8.2	—
$\phi 6.3 \times 8.4$	16.0	7.0	7.0	12.0	1.75	7.5	9.2	—
$\phi 8 \times 10.2(10.5)$	24.0	8.7	8.7	16.0	1.75	11.5	11.1	—
$\phi 10 \times 10.2(10.5)$	24.0	10.7	10.7	16.0	1.75	11.5	11.2	—
$\phi 10 \times 12.5$	24.0	10.7	10.7	16.0	1.75	11.5	13.3	—
$\phi 10 \times 13.5(13.8)$	24.0	10.7	10.7	16.0	1.75	11.5	14.6	—
$\phi 10 \times 16.5$	24.0	10.7	10.7	16.0	1.75	11.5	17.7	—
$\phi 12.5 \times 13.5$	32.0	13.2(13.9★)	13.2(13.9★)	24.0	1.75	14.2	14.3(14.7★)	28.4
$\phi 16 \times 16.5$	44.0	17.5	17.5	28.0	1.75	20.2	17.3(17.8★)	40.4
$\phi 16 \times 21.5$	44.0	17.5	17.5	28.0	1.75	20.2	22.8	40.4
$\phi 18 \times 16.5$	44.0	19.5	19.5	32.0	1.75	20.2	17.8	40.4
$\phi 18 \times 21.5$	44.0	19.5	19.5	32.0	1.75	20.2	22.5	40.4

★ Anti-vibration Structure : CA Type

Reel dimensions

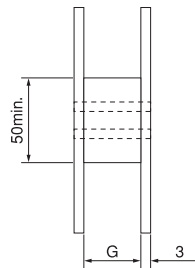
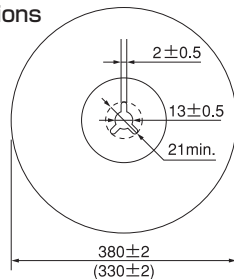

(Unit:mm)

	G
$\phi 4, \phi 5$	14
$\phi 6.3$	18
$\phi 8, \phi 10$	26
$\phi 12.5$	34
$\phi 16, \phi 18$	46

Minimum Packing Quantity

$\phi D \times L$ (mm)	Quantity of 1 Reel($\phi 380$)	Quantity of 1 Reel($\phi 330$)	Quantity of 1 package(Reel)
$\phi 4 \times 5.4$	2000	—	5
$\phi 4 \times 6.0$	2000	—	5
$\phi 5 \times 5.4$	—	1000	5
$\phi 5 \times 6.0$	1000	—	5
$\phi 5 \times 6.0$ EP-cap	1200 ★2	—	5
$\phi 5 \times 7.0$	1000	—	5
$\phi 6.3 \times 4.5$	—	1000	5
$\phi 6.3 \times 5.4$	—	1000	5
$\phi 6.3 \times 6.0$	1000	—	5
$\phi 6.3 \times 7.0$	1000	—	5
$\phi 6.3 \times 7.7$	900	—	5
$\phi 6.3 \times 8.4$	800	—	5
$\phi 8 \times 10.2(10.5)$	500	—	3
$\phi 10 \times 10.2(10.5)$	500	—	3
$\phi 10 \times 12.5$	400	—	3
$\phi 10 \times 13.5(13.8)$	400	—	3
$\phi 10 \times 16.5$	325	—	3
$\phi 12.5 \times 13.5$	250 ★1	—	2
$\phi 16 \times 16.5$	200 ★1	—	2
$\phi 16 \times 21.5$	150 ★2	—	2
$\phi 18 \times 16.5$	175	—	2
$\phi 18 \times 21.5$	125	—	2

Please place your orders with an integral multiple of the minimum packing quantity.

★1 "+D" has to be put after the part number.

Example
25CE2200LXT+D

★2 "+PN" has to be put after the part number.

(For EP-Cap, the quantity per reel is 1200pcs.)

Example
25HVPF33M+PN
25CE2700PHT+PN

The suffix "+P" at the end of the part number indicates a plastic reel.

Example
16CE470LX+P
25CE2200LXT+DP

Radial Lead Type Taping Specifications for Automatic Inserting Machines

Fig.1

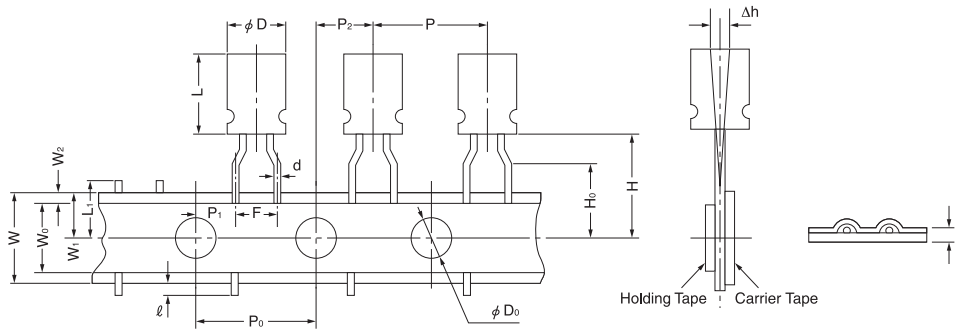

Fig.2

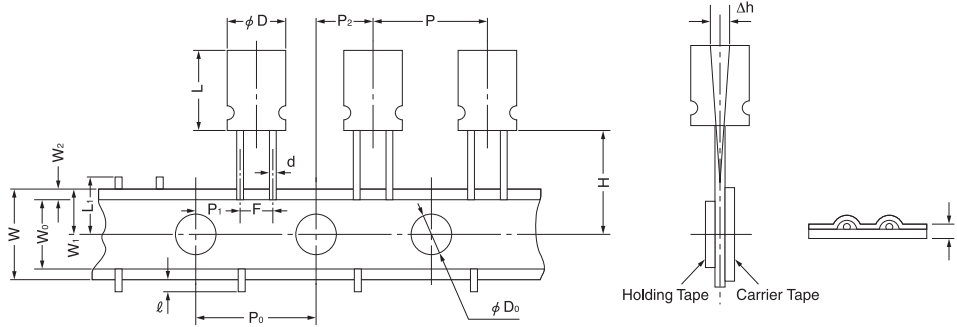
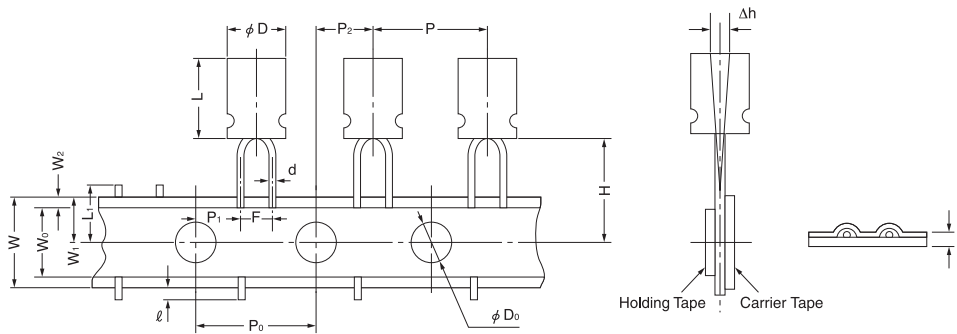

Fig.3



(Unit:mm)

Product Outer Dimensions		φ4 to φ6.3×7 φ6.3×7.5	φ5×11 φ6.3×11	φ8	φ10	φ12.5×20 φ12.5×25	φ16 ×25	φ4 to φ5×7	φ6.3×7 φ6.3×7.5	φ5 ×11	φ6.3 ×11	φ8
Fig. No.		1	1	1	2	2	★3	3	2	3	2	2
Lead wire interval	F	± 0.8 -0.2 ★1	5.0	5.0	5.0	5.0	7.5	2.5	2.5	2.5	2.5	3.5
Pitch between components	P	± 1.0	12.7	12.7	12.7	12.7	15.0	12.7	12.7	12.7	12.7	12.7
Sprocket hole pitch	P ₀	± 0.2	12.7	12.7	12.7	12.7	15.0	12.7	12.7	12.7	12.7	12.7
Sprocket hole position	P ₁	± 0.5	3.85	3.85	3.85	3.85	5.0	5.1	5.1	5.1	5.1	4.6
	P ₂	± 1.0	6.35	6.35	6.35	6.35	7.5	6.35	6.35	6.35	6.35	6.35
Lateral deviation	Δh	± 1.0	0	0	0	0	0	0	0	0	0	0
Carrier tape width	W	± 0.5	18.0	18.0	18.0	18.0	18.0	18.0	18.0	18.0	18.0	18.0
Holding tape width	W ₀	min.	6.0	6.0	6.0	6.0	11.5	6.0	6.0	6.0	6.0	6.0
Sprocket hole position	W ₁	± 0.5	9.0	9.0	9.0	9.0	9.0	9.0	9.0	9.0	9.0	9.0
Holding tape position	W ₂	max.	2.5	2.5	2.5	2.5	2.5	2.5	2.5	2.5	2.5	2.5
Component-base height	H	± 0.75 ★2	17.5	18.5	20.0	16.0	18.5	17.5	18.5	17.5	18.5	18.5
Lead wire clinch height	H ₀	± 0.5	16.0	16.0	16.0	—	—	—	—	—	—	—
Sprocket hole diameter	φD ₀	± 0.2	4.0	4.0	4.0	4.0	4.0	4.0	4.0	4.0	4.0	4.0
Tape thickness(in total)	t	± 0.3	0.6	0.6	0.6	0.6	0.6	0.6	0.6	0.6	0.6	0.6
Lead wire protrusion	ℓ	max.	0	0	0	0	0	0	0	0	0	0
Cut position of failures	L ₁	max.	11.0	11.0	11.0	11.0	11.0	11.0	11.0	11.0	11.0	11.0
Taping code(standard)	Zig-Zag type	+T	+T	+T	+T	+T	+T	+T	+TS	+TS	+TS	+TS

Only straight taping for EP-cap(φ8, φ10).

The taping code has to be put after the part number.

Part number 16ME100HC+T

Taping code

+T0, +TS0 (0=Zero)

★1 Fig.2, Fig.3:±0.5

★2 φ10 · φ12.5 with H=18.5:±0.5

★3 φ16 every two slots in Fig.2

Packaging Specifications

Radial Lead Type Lead-wire Process Standard Specification (Unit:mm)

1. Lead-wire forming

for $\phi D=5,6.3,8\text{mm}$.

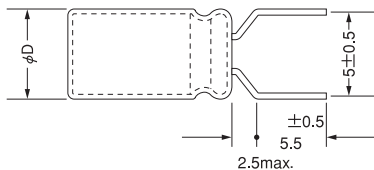

2. Lead-wire cutting

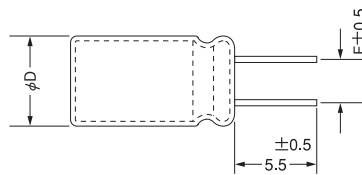

(Unit:mm)

Lead-wire forming is unavailable for EP-cap.

Lead-wire cutting for EP-cap is available only for 10mm diameter case size of the following series. (HEH, HEHZ, HEPZ, HEHF, HEPF, HEPC)

ϕD	5	6.3	8	10	12.5	16	18
F	2.0	2.5	3.5	5.0	5.0	7.5	7.5

The following lead process symbols have to be put after the part number.

Please contact us if a different length of lead-wire is required.

+FA for lead-wire forming

+CA for lead-wire cutting

Example

16ME100CA+FA

200ME10FH+CA

Part number

Example

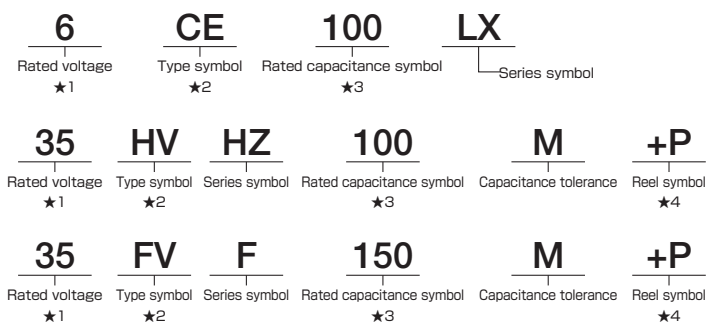

Rated capacitance(μF)	Symbol
0.47	R47
1.0	1
4.7	4R7
10	10
100	100
1000	1000
10000	10000

★1. 6 represents 6.3V as the rated voltage.

★2. Type symbol

CE, HV, FV: Surface mount type

ME, HE: Radial lead type

CA, HA, HC, FA, FC: Surface mount type (Anti-vibration structure)

★3. R represents the decimal point.

★4. Only plastic reels are available for EP-cap. (For the $\phi D=5$, put "+PN")

Minimum Packing Quantity

Bulk

Size	Quantity	Remarks reference
$\phi 4$ to $\phi 8$ ★1	500 PCS.	★1 $\phi 8 \times 12.5\text{L}$; 200 PCS. (ME-WA, ME-WG series Size $\phi 8 \times 11.5\text{L}$; 200 PCS.) ★2 $\phi 12.5 \times 30\text{L}$; 100 PCS. ★3 $\phi 16 \times 35.5\text{L}$; 50 PCS. Surface Mount Type ; Please refer to page 11
$\phi 10$ to $\phi 12.5$ ★2	200 PCS.	
$\phi 16$ ★3	100 PCS.	
$\phi 18$	50 PCS.	

Taping

Size	Quantity
$\phi 4$	4000 PCS.
$\phi 5$	3000 PCS.
$\phi 6.3$	2500 PCS.
$\phi 8$	1400 PCS.
$\phi 10$	900 PCS.
$\phi 12.5$	600 PCS.
$\phi 16$	250 PCS.

Please place your orders with an integral multiple of the minimum packing quantity.

Ripple Current Frequency Coefficient

■ Ripple Current Frequency Coefficient

Series	Capacitance:C(μ F)	Frequency:f(Hz)			
		100≤f<1k	1k≤f<10k	10k≤f<100k	100k≤f
CE-LD CE-FSS, CE-FS(6.3 to 100V) CE-LH(6.3 to 50V), CE-FN	C≤4.7	1.00	1.30	1.50	1.80
	4.7<C≤33	1.00	1.20	1.30	1.45
	33<C	1.00	1.10	1.20	1.30
CE-AX CE-LX CE-ZX	C≤33	0.35	0.70	0.90	1.00
	33<C≤150	0.40	0.85	0.92	1.00
	150<C	0.60	0.85	0.95	1.00
CE-ZC	ALL	0.55	0.80	0.85	1.00
CE-GA	C≤1	0.07	0.55	0.85	1.00
	1<C≤4.7	0.25	0.60	0.90	1.00
	4.7<C≤47	0.45	0.75	0.92	1.00
	47<C	0.60	0.85	0.92	1.00
CE-LS CE-LL, CE-LF CE-PC	C≤22	0.50	0.80	0.90	1.00
	22<C≤150	0.65	0.85	0.92	1.00
	150<C	0.70	0.85	0.95	1.00
CE-PH, CE-PF CE-PS, CE-TH, CE-JX	C≤10	0.50	0.80	0.90	1.00
	10<C	0.60	0.85	0.93	1.00

Series	Capacitance:C(μ F)	Frequency:f(Hz)		
		100≤f<1k	1k≤f<10k	10k≤f
ME-FC, ME-FD, ME-FH ME-SWN, ME-HWN	C<100	1.00	1.30	1.50
	100≤C<1000	1.00	1.20	1.30
	1000≤C	1.00	1.13	1.15
ME-CX ME-AX	C≤68	0.50	0.80	1.00
	68<C≤220	0.55	0.85	1.00
	220<C≤1000	0.65	0.90	1.00
	1000<C	0.75	0.90	1.00
ME-CZ ME-CA ME-FX	C≤1	0.20	0.60	1.00
	1<C≤47	0.50	0.80	1.00
	47<C≤220	0.55	0.85	1.00
	220<C≤1000	0.65	0.90	1.00
1000<C	0.75	0.90	1.00	

Series	Capacitance:C(μ F)	Frequency:f(Hz)			
		100≤f<1k	1k≤f<10k	10k≤f<100k	100k≤f
ME-SAX	C≤47	0.40	0.80	0.90	1.00
	47<C≤100	0.60	0.80	0.95	1.00
	100<C	0.75	0.85	0.95	1.00
ME-SZ ME-LS	C≤4.7	0.50	0.65	0.95	1.00
	4.7<C≤33	0.60	0.75	0.95	1.00
	33<C	0.75	0.85	0.95	1.00
ME-WX ME-WA ME-WL	C≤33	0.40	0.65	0.90	1.00
	33<C≤1200	0.50	0.80	0.93	1.00
	1200<C	0.60	0.85	0.96	1.00
ME-WG	C≤820	0.45	0.80	0.94	1.00
	820<C≤1800	0.50	0.85	0.96	1.00
	1800<C	0.55	0.88	0.98	1.00
ME-SWG	C≤56	0.22	0.45	0.65	1.00
	56<C	0.28	0.50	0.65	1.00

Series	Capacitance:C(μ F)	Frequency:f(Hz)				
		50	120	300	1k	10k≤f
CE-FS(160 to 400V) CE-LH(160 to 400V)	ALL	0.75	1.00	1.20	1.30	1.50

Please refer to page 18 for Ripple Current Frequency Coefficient of EP-cap.

CA Type

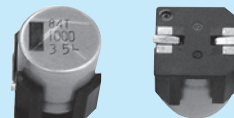

- Suitable for Automotive Applications

■ Dimensions

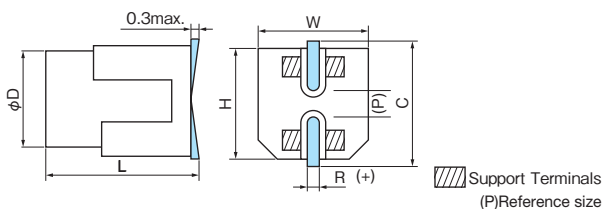

A pressure relief vent is provided for $\phi D=8$ or bigger

(Unit : mm)

D ± 0.5	L	W ± 0.2	H ± 0.2	C ± 0.2	R	P
8	10.5 ± 0.5	8.3	8.3	9.0	0.7 to 1.0	3.2
8	10.7 ± 0.5 ★	8.3	8.3	9.0	0.7 to 1.0	3.2
10	10.5 ± 0.5	10.3	10.3	11.0	1.0 to 1.4	4.6
10	10.7 ± 0.5 ★	10.3	10.3	11.0	1.0 to 1.4	4.6
10	13.5 ± 1.0	10.3	10.3	11.0	1.0 to 1.4	4.6
12.5	13.5 ± 1.0	13.5	13.5	14.2	1.0 to 1.4	4.6
16	16.5 ± 1.0	17.0	17.0	18.0	1.7 to 2.1	7.0
18	16.5 ± 1.0	19.0	19.0	20.0	1.7 to 2.1	7.0
18	21.5 ± 1.0	19.0	19.0	20.0	1.7 to 2.1	7.0

★ CA-ZX, CA-ZC, CA-LF, CA-PH, CA-PS, CA-PF, CA-TH, CA-JX
CA-FS(160 to 400V), CA-LH(160 to 400V)

■ Surface Mount Type Recommended land pattern

Land pattern
(Anti-vibration Structure)

(Unit : mm)

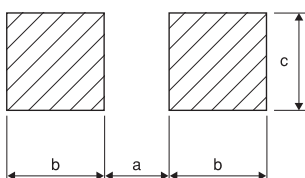

Size	a	b	c
$\phi 8$	2.5	4.5	4.7
$\phi 10$	3.8	4.8	4.7
$\phi 12.5$	3.8	6.1	6.9
$\phi 16$	5.0	8.0	9.5
$\phi 18$	5.0	8.6	9.5

■ Part number CA Type

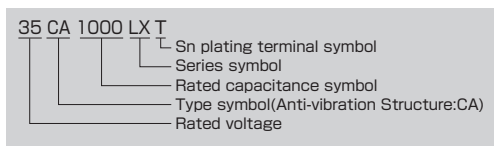

HA Type · HC Type · FA Type · FC Type



- Suitable for Automotive Applications

■ Dimensions

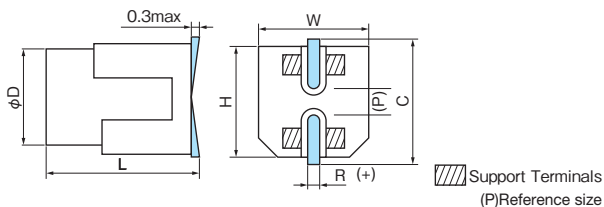

A pressure relief vent is provided for $\phi D=8$ or bigger

(Unit : mm)

Type	D ± 0.5	L	W ± 0.2	H ± 0.2	C ± 0.2	R	P
HA, FA	6.3	6.0 ± 0.5 ★	6.6	6.6	7.3	0.5 to 0.8	2.2
HA, FA	6.3	7.7 ± 0.5 ★	6.6	6.6	7.3	0.5 to 0.8	2.2
HA, FA	8	10.7 ± 0.5	8.3	8.3	9.0	0.7 to 1.0	3.2
HC, FC	10	10.7 ± 0.5	10.3	10.3	11.0	1.0 to 1.4	4.6
HC, FC	10	12.5 ± 0.5	10.3	10.3	11.0	1.0 to 1.4	4.6
FC	10	13.8 ± 0.5	10.3	10.3	11.0	1.0 to 1.4	4.6
FC	10	16.5 ± 0.5	10.3	10.3	11.0	1.0 to 1.4	4.6

★ Please contact us for applicable series.

■ Surface Mount Type Recommended land pattern

Land pattern
(Anti-vibration Structure)

(Unit : mm)

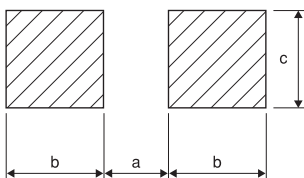

Size	a	b	c
ϕ 6.3	1.6	4.0	3.0
ϕ 8	2.5	4.5	4.7
ϕ 10	3.8	4.8	4.7

■ Part number

HA Type · HC Type **EP-cap**

FA Type · FC Type **EP-cap**

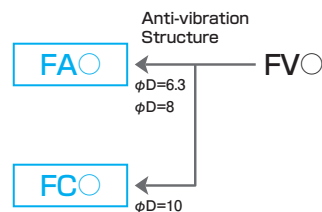
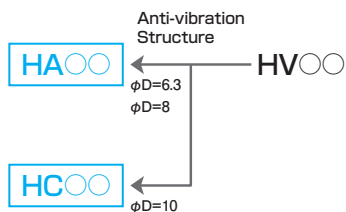
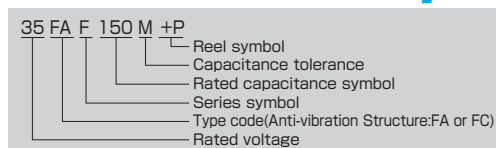
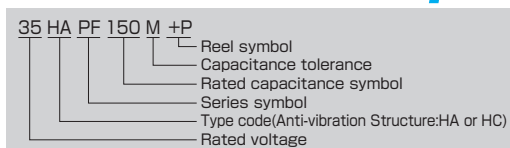

EP-cap Hybrid Conductive Polymer Type

EP-cap is the first hybrid cathode aluminum electrolytic capacitors in the industry using a liquid electrolyte and a high conductive polymer. EP-cap is very low ESR (equivalent series resistance) at high frequencies comparing with the standard aluminum electrolytic capacitors. EP-cap has a self-healing mechanism of the dielectric due to a chemical reaction of the liquid electrolyte. High voltage 125V, high reliability 135°C, high ripple current, long life (HVTYseries) and high temperature 150°C (FVF series) are ready in the line-up.

Soldering Condition
Reflow Soldering Condition
Ripple Current
Frequency
Coefficient

FVL
HVHZ-HVH
HVPZ-HVP
HVT
HVHF
HVPF
HVPX
HVTX
HVHY
HVPY
HVTY
HVHC
HVPC
FVC
FVF
FVS
HEHF
HEPF
HEPC

Basic Construction

EP-cap

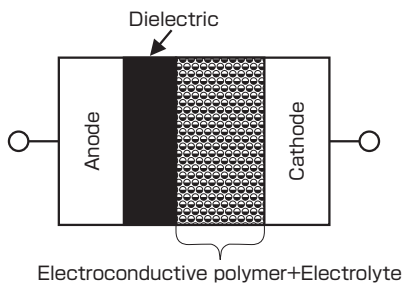

Electrolytic Capacitor

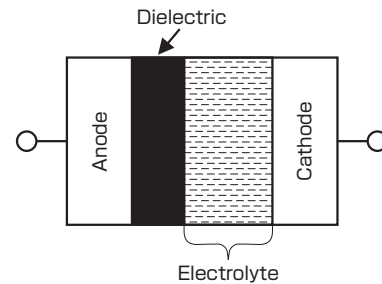

Features

- **Low ESR**
(Downsize and upgrade your circuit)
 - Excellent noise absorption capability at high frequency.
 - High ripple current. Suitable for smoothing in switching regulators.
- **Excellent low temperature characteristics**
 - Stable performance at low temperatures
- **Self-healing property of the liquid electrolyte**
 - Less possibility of a short-circuit than the solid polymer capacitors. Low leakage current.
- **Rated voltage up to 125V.**
- **150°C high temperature**
- **Applying a voltage up to the rated voltage is guaranteed.**
 - Voltage derating is not necessary
- **RoHS compliance**
(Environmental friendly)

Frequency characteristics

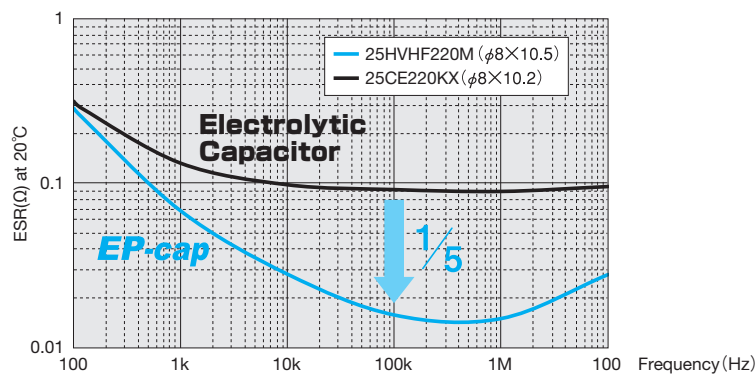

Temperature characteristics

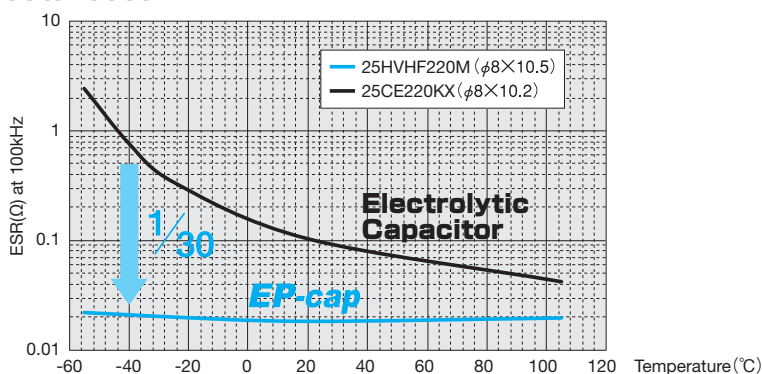

■ Soldering Condition

- Soldering with a soldering iron : within 3 seconds at 350°C unless otherwise specified in the spec.
- Flow soldering : within 10 seconds at 260°C unless otherwise specified in the spec.
(Do not flow soldering with SMD type.)
- Thermal curing oven : within 2 minutes at below 150°C ambient

■ Reflow Soldering Condition

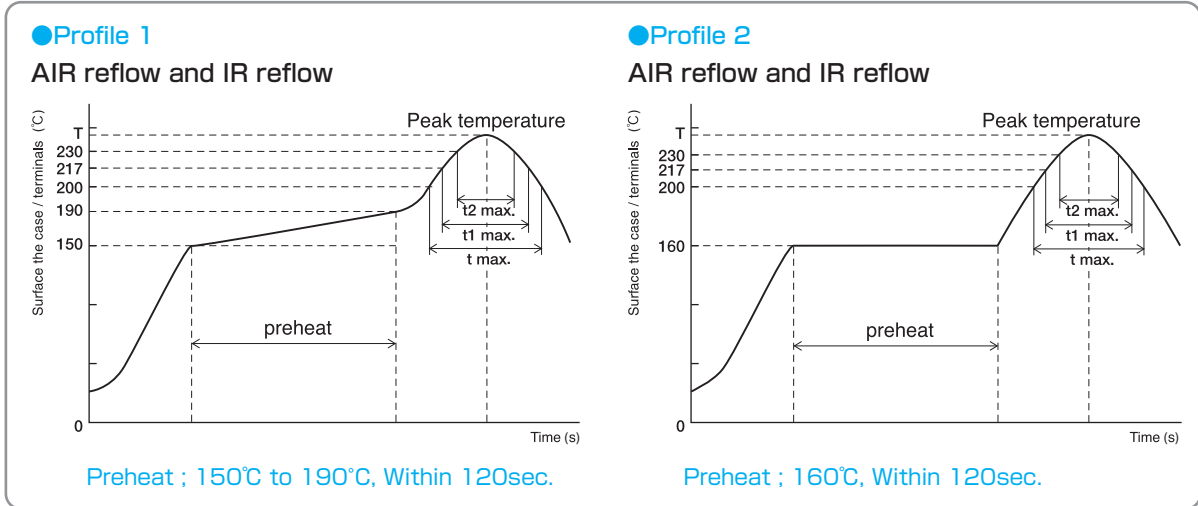

Series	Voltage (V)	Size	Time of more than 200°C(t)	Time of more than 217°C(t1)	Time of more than 230°C(t2)	Peak temperature (T)	Reflow cycle	Profile
HVH, HVP HVT, HVJ HVHZ, HVPZ	16 to 63	ALL	Within 100sec.	Within 80sec.	Within 40sec.	260°C ★1	2	1
	80 to 125	ALL	Within 100sec.	Within 80sec.	Within 40sec.	250°C ★1	2	1
HVHF, HVPF HVPX, HVTX HVHC, HVPC HVHY, HVPY HVTY, FVL FVC, FVF FVS	6.3 to 63	ALL	Within 70sec.	Within 40sec.	Within 30sec.	260°C ★2	2	2
	80 to 100	ALL	Within 70sec.	Within 40sec.	Within 30sec.	245°C ★3	2	2

In case two cycles of reflow soldering is allowed in the spec, the second reflow soldering must be done after natural air cooling for more than one hour in order to return the temperature of a circuit board and components to room temperature.

- ★1 Within 5sec.
- ★2 Less than 260°C
- ★3 Less than 245°C

■ Ripple Current Frequency Coefficient

Series	Capacitance : C (μF)	Frequency : f (Hz)								
		100≤f<1k	1k≤f<5k	5k≤f<10k	10k≤f<20k	20k≤f<30k	30k≤f<40k	40k≤f<50k	50k≤f<100k	100k≤f<500k
HVH, HVP, HVT, HVJ HVHZ, HVPZ, HVHF HVPF, HVPX, HVTX HVHY, HVPY, HVTY HVHC, HVPC FVL, FVC	C≤22	0.05	0.25	0.45	0.55	0.65	0.70	0.75	0.80	1.00
	22<C≤47	0.10	0.35	0.55	0.65	0.75	0.80	0.80	0.85	1.00
	47<C≤150	0.10	0.40	0.65	0.70	0.80	0.85	0.85	0.90	1.00
HEH, HEHZ, HEPZ HEHF, HEPF, HEPC	150<C	0.15	0.45	0.65	0.75	0.80	0.85	0.85	0.90	1.00
FVF	ALL	0.15	0.35	0.55	0.65	0.75	0.80	0.85	0.90	1.00
FVS	ALL	0.10	0.20	0.40	0.50	0.65	0.75	0.80	0.85	1.00

A peak voltage with a ripple current shall be less than the rated voltage.
A peak voltage with a ripple current shall not be a reverse voltage.

FVL Series

105°C · 125°C



- 105°C : 5,000hours, 125°C : 2,000hours
- 85°C, 85%RH 1,000 to 2,000hours
- Solvent proof (within 2 minutes) ● AEC-Q200

Specifications

Items	Condition	Specifications		
Rated voltage (V)	—	6.3	10	
Surge voltage (V)	Room temperature	8.2	13	
Category temperature range (°C)	—	-55 to +125		
Capacitance tolerance (%)	120Hz/20°C	M : ±20		
Dissipation Factor (tan δ)	tanδ (max.) 120Hz/20°C	0.18	0.16	
Leakage current (LC)	μA/after 2minutes (max.), 20°C	The greater value of either 0.05CV or 100		
Endurance	rated voltage applied (With the rated ripple current)	Test	105°C : 5,000hours, 125°C : 2,000hours	
		ΔC/C	Within ±30% of the initial value	
		tanδ	Less than 200% of the specified value	
		ESR	Less than 200% of the specified value	
		LC	Less than the specified value	
Bias Humidity Test	85°C, 85%RH rated voltage applied	Test	φ6.3 : 1,000hours, φ8, φ10 : 2,000hours	
		ΔC/C	Within ±30% of the initial value	
		tanδ	Less than 200% of the specified value	
		ESR	Less than 200% of the specified value	
		LC	Less than the specified value	

Aluminum Electrolytic Capacitors with Hybrid Conductive Polymer

Soldering Condition
Reflow Soldering Condition
Ripple Current Frequency Coefficient

FVL

HVHZ-HVH

HVPZ-HVP

HVT

HVHF

HVPF

HVPX

HVTX

HVHY

HVPY

HVTY

HVHC

HVPC

FVC

FVF

FVS

HEHF

HEPF

HEPC

Marking, Dimensions

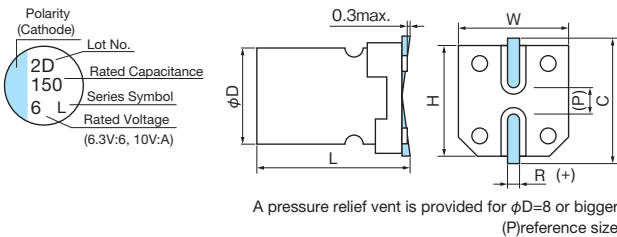

(Unit : mm)

D ^{+0.5}	L ^{+0.3}	W ^{+0.2}	H ^{+0.2}	C ^{+0.2}	R	P
6.3	6.0	6.6	6.6	7.3	0.5 to 0.8	2.2
6.3	7.7	6.6	6.6	7.3	0.5 to 0.8	2.2
8	10.5	8.3	8.3	9.0	0.7 to 1.0	3.2
10	10.5	10.3	10.3	11.0	1.0 to 1.4	4.6

Size, ESR, Rated Ripple Current

Items μF	6.3				10			
	Case size φDxL (mm)	ESR (mΩmax.) (20°C/100kHz)	Rated ripple current (mA rms/100kHz)		Case size φDxL (mm)	ESR (mΩmax.) (20°C/100kHz)	Rated ripple current (mA rms/100kHz)	
			105°C	125°C			105°C	125°C
100					6.3x6.0	36	1700	950
150	6.3x6.0	36	1700	950	6.3x7.7	32	2100	1150
220	6.3x7.7	32	2100	1150				
470					8x10.5	16	3200	1800
560	8x10.5	16	3200	1800				
820					10x10.5	15	3900	2200
1000	10x10.5	15	3900	2200				

Please refer to page 18 for ripple current frequency coefficients.

Part number

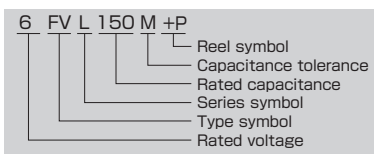

HVHZ • HVH Series

(16V to 35V) (50V to 125V)

105°C Long Life

- 105°C 4,000 to 10,000hours
- Solvent proof (within 2 minutes)
- AEC-Q200

■ Specifications

Items	Condition	Specifications							
Rated voltage (V)	—	16	25	35	50	63	80	100	125
Surge voltage (V)	Room temperature	20	32	44	63	79	100	125	157
Category temperature range (°C)	—	-55 to +105							
Capacitance tolerance (%)	120Hz/20°C	M : ±20							
Dissipation Factor (tan δ)	tanδ (max.) 120Hz/20°C	0.16							
Leakage current(LC)	μA/after 2minutes (max.) (20°C)	0.01CV							
Endurance	105°C rated voltage applied (With the rated ripple current)	≤ 63V	The greater value of either 0.05CV or 100						
		80V ≤	The greater value of either 0.05CV or 100						
		Test 16V	φ6.3 : 4,000hours, D≥φ8 : 7,000hours						
		25V≤	φ6.3 : 5,000hours, D≥φ8 : 10,000hours						
		ΔC/C	Within ±30% of the initial value						
		tanδ	Less than 200% of the specified value						
		ESR	Less than 200% of the specified value						
		LC	Less than the specified value						

■ Marking, Dimensions

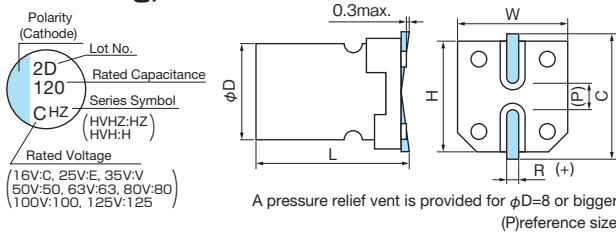

(Unit : mm)

D ^{±0.5}	L ^{±0.3}	W ^{±0.2}	H ^{±0.2}	C ^{±0.2}	R	P
6.3	6.0	6.6	6.6	7.3	0.5 to 0.8	2.2
6.3	7.7	6.6	6.6	7.3	0.5 to 0.8	2.2
8	10.5	8.3	8.3	9.0	0.7 to 1.0	3.2
10	10.5	10.3	10.3	11.0	1.0 to 1.4	4.6
10	12.5	10.3	10.3	11.0	1.0 to 1.4	4.6

■ Size, ESR, Rated Ripple Current

Series	HVHZ								HVH				
	16		25		35		50		63		80	100	125
10									6.3×6.0 ★	120	980		
15									6.3×7.7	80	1200		
27						6.3×6.0	50	1530					
33									8×10.5	35	1670		
47			6.3×6.0	40	1800	6.3×7.7	45	1840					
56									10×10.5	25	2320		
68			6.3×7.7	35	1980								
82	6.3×6.0	38	1890						10×12.5	19	2650		
100								8×10.5	28	2550			
120	6.3×7.7	32	2070										
150				8×10.5	25	2690	10×10.5	20	3490				
220							10×12.5	15	4000				
270	8×10.5	23	2820	10×10.5	19	3580							
330				10×12.5	14	4140							
470	10×10.5	18	3750										
560	10×12.5	14	4340										

Series	HVH												
	63		80		100		125		100		125		
6.8	6.3×6.0	150	960										
10	6.3×7.7	100	1060			10×10.5	80	1450	10×10.5	90	1250		
12				10×10.5	70	1600	10×10.5	80	1450				
15				10×10.5	70	1600	10×12.5	60	1660				
18				10×12.5	50	1830							
22	8×10.5	40	1560										
33	8×10.5 ★	40	1560										
	10×10.5	30	2100										
47	10×10.5	30	2100										
56	10×12.5	22	2400										

Please refer to page 18 for ripple current frequency coefficients.

★ S type

ESR(mΩ)max. at 100kHz, 20°C
Case size:φDxL(mm) Rated ripple current mA Arms(100kHz, 105°C)

■ Part number

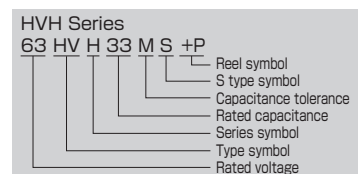
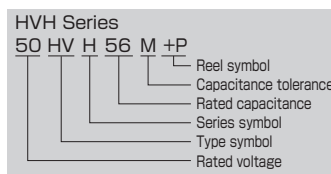
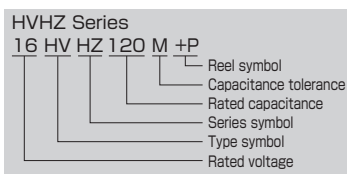

HVPZ·HVP Series

(16V to 35V) (50V to 125V)

125°C

- 125°C 2,000 to 3,000hours
- Solvent proof (within 2 minutes)
- AEC-Q200

■ Specifications

Items	Condition	Specifications							
Rated voltage (V)	—	16	25	35	50	63	80	100	125
Surge voltage (V)	Room temperature	20	32	44	63	79	100	125	157
Category temperature range (°C)	—	-55 to +125							
Capacitance tolerance (%)	120Hz/20°C	M : ±20							
Dissipation Factor (tan δ)	tanδ (max.) 120Hz/20°C	0.16							
Leakage current (LC)	μA/after 2minutes (max.) (20°C)	≤ 63V	0.01CV						
		80V ≤	The greater value of either 0.05CV or 100						
Endurance	125°C rated voltage applied (With the rated ripple current)	Test	16V	φ6.3 : 2,000hours, D≥φ8 : 2,500hours					
			25V ≤	φ6.3 : 2,000hours, D≥φ8 : 3,000hours					
		ΔC/C	Within ±30% of the initial value						
		tanδ	Less than 200% of the specified value						
		ESR	Less than 200% of the specified value						
		LC	Less than the specified value						

■ Marking, Dimensions

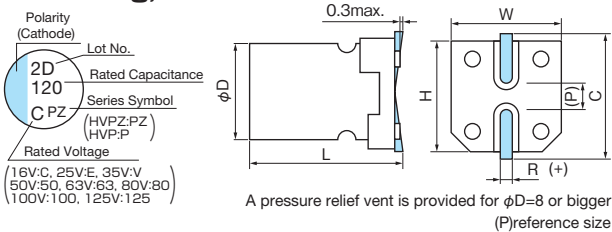

(Unit : mm)

D ^{+0.5}	L ^{+0.3}	W ^{+0.2}	H ^{+0.2}	C ^{+0.2}	R	P
6.3	6.0	6.6	6.6	7.3	0.5 to 0.8	2.2
6.3	7.7	6.6	6.6	7.3	0.5 to 0.8	2.2
8	10.5	8.3	8.3	9.0	0.7 to 1.0	3.2
10	10.5	10.3	10.3	11.0	1.0 to 1.4	4.6
10	12.5	10.3	10.3	11.0	1.0 to 1.4	4.6

■ Size, ESR, Rated Ripple Current

Series	V	HVPZ				HVP		
		16	25	35	50			
10					6.3×6.0 ★	120	690	
15					6.3×7.7	80	840	
27				6.3×6.0	50	1070		
33					8×10.5	35	1170	
47			6.3×6.0	40	1260			
56						10×10.5	25	1390
68			6.3×7.7	35	1380			
82	6.3×6.0	38	1320			10×12.5	19	1590
100						8×10.5	28	1780
120	6.3×7.7	32	1440					
150			8×10.5	25	1880	10×10.5	20	2440
220						10×12.5	15	2800
270	8×10.5	23	1970	10×10.5	19	2500		
330				10×12.5	14	2890		
470	10×10.5	18	2620					
560	10×12.5	14	3030					

Series	V	HVP			
		63	80	100	125
6.8	6.3×6.0	150	670		
10	6.3×7.7	100	740		
12			10×10.5	70	900
15			10×10.5	70	900
18			10×12.5	50	1100
22	8×10.5	40	1090		
33	8×10.5 ★	40	1090		
	10×10.5	30	1260		
47	10×10.5	30	1260		
56	10×12.5	22	1440		

Please refer to page 18 for ripple current frequency coefficients.

★ S type

ESR(mΩ)max. at 100kHz, 20°C
Case size: φDxL(mm) Rated ripple current mArms(100kHz, 125°C)

■ Part number

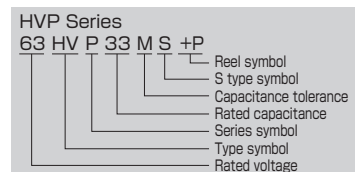
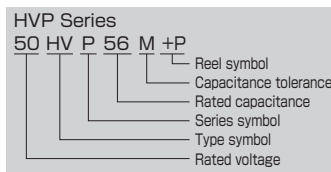
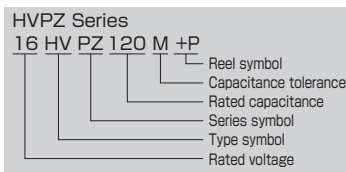

Soldering Condition
Reflow Soldering Condition
Ripple Current Frequency Coefficient

FVL

HVHZ·HVH

HVPZ·HVP

HVT

HVHF

HVPF

HVPX

HVTX

HVHY

HVPY

HVTY

HVHC

HVPC

FVC

FVF

FVS

HEHF

HEPF

HEPC

HVT Series

135°C



- 135°C 1,000 to 2,000hours
- Solvent proof (within 2 minutes)
- AEC-Q200

Specifications

Items	Condition	Specifications				
Rated voltage (V)	—	25	35	40	50	63
Surge voltage (V)	Room temperature	32	44	50	63	79
Category temperature range (°C)	—	-55 to +135				
Capacitance tolerance (%)	120Hz/20°C	M : ±20				
Dissipation Factor (tan δ)	tanδ (max.) 120Hz/20°C	0.16				
Leakage current (LC)	μA/after 2minutes (max.), 20°C	The greater value of either 0.01CV				
Endurance	135°C rated voltage applied (With the rated ripple current)	Test	φ6.3 : 1,000hours, D _≥ φ8 : 2,000hours			
		ΔC/C	Within ±30% of the initial value			
		tanδ	Less than 200% of the specified value			
		ESR	Less than 200% of the specified value			
		LC	Less than the specified value			

Marking, Dimensions

Polarity (Cathode)
 Lot No.
 Rated Capacitance
 Series Symbol
 Rated Voltage

(Unit : mm)

D ^{±0.5}	L ^{±0.3}	W ^{±0.2}	H ^{±0.2}	C ^{±0.2}	R	P
6.3	7.7	6.6	6.6	7.3	0.5 to 0.8	2.2
8	10.5	8.3	8.3	9.0	0.7 to 1.0	3.2
10	10.5	10.3	10.3	11.0	1.0 to 1.4	4.6
10	12.5	10.3	10.3	11.0	1.0 to 1.4	4.6

A pressure relief vent is provided for φD=8 or bigger (P)reference size

Size, ESR, Rated Ripple Current

μF	V	25			35			40			50		
		15									6.3×7.7	80	670
27							6.3×7.7	70	700				
33										8×10.5	35	940	
47				6.3×7.7	60	730							
56							8×10.5	32	980	10×10.5	25	1110	
68	6.3×7.7	45	780										
82										10×12.5	19	1270	
100				8×10.5	30	1010	10×10.5	24	1150				
120							10×12.5	18	1320				
150	8×10.5	27	1060	10×10.5	23	1180							
220				10×12.5	17	1360							
270	10×10.5	22	1220										
330	10×12.5	16	1390										

μF	V	63		
		10	6.3×7.7	100
22	8×10.5	40	870	
33	8×10.5★	40	870	
	10×10.5	30	1010	
47	10×10.5	30	1010	
56	10×12.5	22	1150	

Case size: φDxL (mm)

ESR (mΩ) max. at 100kHz, 20°C

Rated ripple current (mArms) (100kHz, 135°C)

Please refer to page 18 for ripple current frequency coefficients.

★ S type

Part number

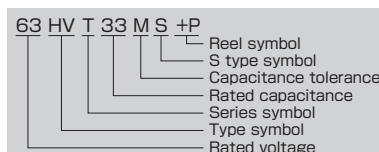
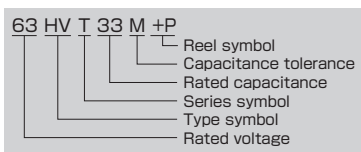

HVHF Series

105°C Long Life

High Capacitance



- 105°C 5,000 to 10,000hours
- Solvent proof (within 2 minutes)
- AEC-Q200

Specifications

Items	Condition	Specifications					
Rated voltage (V)	—	25	35	50	63	80	100
Surge voltage (V)	Room temperature	32	44	63	79	100	125
Category temperature range (°C)	—	-55 to +105					
Capacitance tolerance (%)	120Hz/20°C	M : ±20					
Dissipation Factor(tan δ)	tanδ (max.) 120Hz/20°C	0.14	0.12	0.10	0.08	0.08	0.08
Leakage current (LC)	μA/after 2minutes (max.), 20°C	The greater value of either 0.01CV					
Endurance	105°C rated voltage applied (With the rated ripple current)	Test	10,000hours(φ6.3×6.0 5,000hours)				
		ΔC/C	Within ±30% of the initial value				
		tanδ	Less than 200% of the specified value				
		ESR	Less than 200% of the specified value				
		LC	Less than the specified value				

Marking, Dimensions

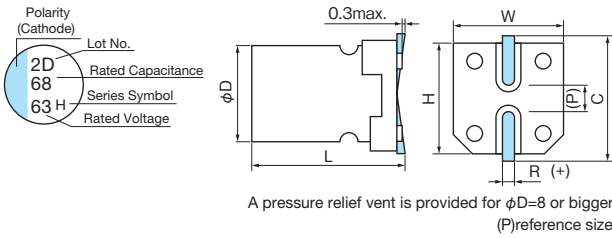

(Unit : mm)

D ^{+0.5}	L ^{+0.3}	W ^{+0.2}	H ^{+0.2}	C ^{+0.2}	R	P
6.3	6.0	6.6	6.6	7.3	0.5 to 0.8	2.2
6.3	7.7	6.6	6.6	7.3	0.5 to 0.8	2.2
8	10.5	8.3	8.3	9.0	0.7 to 1.0	3.2
10	10.5	10.3	10.3	11.0	1.0 to 1.4	4.6
10	12.5	10.3	10.3	11.0	1.0 to 1.4	4.6

Size, ESR, Rated Ripple Current

μF \ V	25	35	50	63	80	100
10				6.3×6.0 120,1000		8×10.5 60,1400
15				6.3×6.0★ 120,1000 6.3×7.7 80,1500		10×10.5 45,1500
18						10×12.5 40,1580
22			6.3×6.0 80,1100	6.3×7.7 80,1500	8×10.5 45,1550	
27					8×10.5 45,1550	
33			6.3×7.7 40,1600	8×10.5 40,1700	10×10.5 36,1700	
39					10×12.5 32,1800	
47		6.3×6.0 60,1300		8×10.5 40,1700	10×10.5 36,1700	
56	6.3×6.0 50,1300			10×10.5 30,1800	10×12.5 32,1800	
68		6.3×7.7 35,2000	8×10.5 30,1800	10×12.5 22,2100		
82				10×10.5 30,1800		
100	6.3×7.7 30,2000			10×12.5 22,2100		
120			10×10.5 28,2000			
150		8×10.5 27,2300	10×12.5 19,2300			
220	8×10.5 27,2300					
270		10×10.5 20,2500				
330	10×10.5 20,2500	10×12.5 17,2800				
470	10×12.5 16,2800					

Please refer to page 18 for ripple current frequency coefficients.

★ S type

ESR(mΩ)max. at 100kHz, 20°C
Case size:φDxL(mm)

Rated ripple current
mA Arms(100kHz, 105°C)

Part number

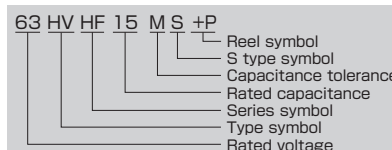
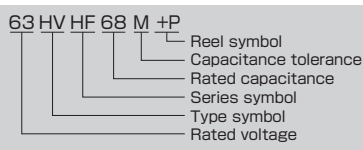

Soldering Condition
Reflow Soldering Condition
Ripple Current Frequency Coefficient

FVL

HVHZ-HVH

HVPZ-HVP

HVT

HVHF

HVPF

HVPX

HVTX

HVHY

HVPY

HVTY

HVHC

HVPC

FVC

FVF

FVS

HEHF

HEPF

HEPC

HVPF Series

125°C

High Capacitance



- 125°C 4,000hours
- Solvent proof (within 2 minutes)
- AEC-Q200

Specifications

Items	Condition	Specifications					
Rated voltage (V)	—	25	35	50	63	80	100
Surge voltage (V)	Room temperature	32	44	63	79	100	125
Category temperature range (°C)	—	-55 to +125					
Capacitance tolerance (%)	120Hz/20°C	M : ±20					
Dissipation Factor (tan δ)	tanδ (max.) 120Hz/20°C	0.14	0.12	0.10	0.08	0.08	0.08
Leakage current (LC)	μA/after 2minutes (max.), 20°C	The greater value of either 0.01CV					
Endurance	125°C, 4,000hours rated voltage applied (With the rated ripple current)	ΔC/C	Within ±30% of the initial value				
		tanδ	Less than 200% of the specified value				
		ESR	Less than 200% of the specified value				
		LC	Less than the specified value				

Marking, Dimensions

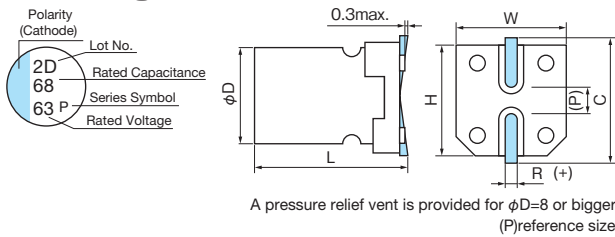

(Unit : mm)

D ^{+0.5}	L ^{+0.3}	W ^{+0.2}	H ^{+0.2}	C ^{+0.2}	R	P
5	6.0	5.3	5.3	6.0	0.5 to 0.8	1.4
6.3	6.0	6.6	6.6	7.3	0.5 to 0.8	2.2
6.3	7.7	6.6	6.6	7.3	0.5 to 0.8	2.2
8	10.5	8.3	8.3	9.0	0.7 to 1.0	3.2
10	10.5	10.3	10.3	11.0	1.0 to 1.4	4.6
10	12.5	10.3	10.3	11.0	1.0 to 1.4	4.6

Size, ESR, Rated Ripple Current

μF \ V	25	35	50	63	80	100
10				5x6.0 ★ 120, 500 6.3x6.0 120, 700		8x10.5 60, 900
15				6.3x6.0 ★ 120, 700 6.3x7.7 80, 900		10x10.5 45, 1120
18						10x12.5 40, 1220
22		5x6.0 100, 550	6.3x6.0 80, 750	6.3x7.7 80, 900	8x10.5 45, 1030	
27					8x10.5 45, 1030	
33	5x6.0 80, 550		6.3x7.7 40, 1100	8x10.5 40, 1100	10x10.5 36, 1270	
39					10x12.5 32, 1360	
47		6.3x6.0 60, 900		8x10.5 40, 1100	10x10.5 36, 1270	
56	6.3x6.0 50, 900			10x10.5 30, 1400	10x12.5 32, 1360	
68		6.3x7.7 35, 1400	8x10.5 30, 1250	10x12.5 22, 1650		
82				10x10.5 30, 1400		
100	6.3x7.7 30, 1400			10x12.5 22, 1650		
120			10x10.5 28, 1600			
150		8x10.5 27, 1600	10x12.5 19, 1820			
220	8x10.5 27, 1600					
270		10x10.5 20, 2000				
330	10x10.5 20, 2000	10x12.5 17, 2260				
470	10x12.5 16, 2260					

Please refer to page 18 for ripple current frequency coefficients.
★ S type

ESR(mΩ)max. at 100kHz, 20°C
Case size: φDxL(mm)

Rated ripple current
mA rms (100kHz, 125°C)

Part number

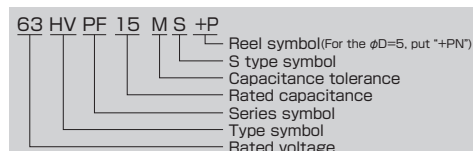
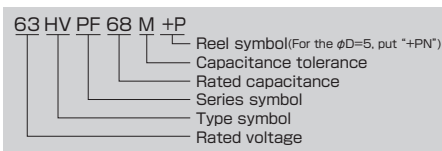

HVPX Series

125°C

High Ripple Current



- 125°C 4,000hours
- Solvent proof (within 2 minutes)
- AEC-Q200

Specifications

Items	Condition	Specifications				
Rated voltage (V)	—	25	35	50	63	80
Surge voltage (V)	Room temperature	32	44	63	79	100
Category temperature range (°C)	—	-55 to +125				
Capacitance tolerance (%)	120Hz/20°C	M : ±20				
Dissipation Factor (tan δ)	tanδ (max.) 120Hz/20°C	0.14	0.12	0.10	0.08	0.08
Leakage current (LC)	μA/after 2minutes (max.), 20°C	0.01CV				
Endurance	125°C, 4,000hours rated voltage applied (With the rated ripple current)	ΔC/C	Within ±30% of the initial value			
		tanδ	Less than 200% of the specified value			
		ESR	Less than 200% of the specified value			
		LC	Less than the specified value			

Marking, Dimensions

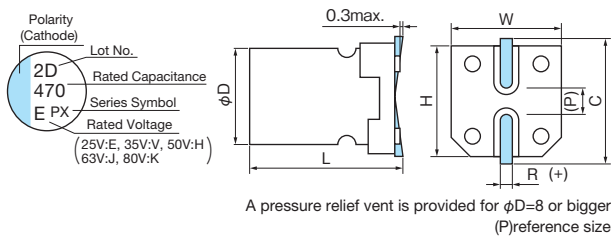

(Unit : mm)

D ^{+0.5}	L ^{+0.3}	W ^{+0.2}	H ^{+0.2}	C ^{+0.2}	R	P
6.3	6.0	6.6	6.6	7.3	0.5 to 0.8	2.2
6.3	7.7	6.6	6.6	7.3	0.5 to 0.8	2.2
8	10.5	8.3	8.3	9.0	0.7 to 1.0	3.2
10	10.5	10.3	10.3	11.0	1.0 to 1.4	4.6
10	12.5	10.3	10.3	11.0	1.0 to 1.4	4.6

Size, ESR, Rated Ripple Current

μF \ V	25	35	50	63	80
22					8×10.5 45 2000
33					8×10.5★ 45 2000 10×10.5 36 2550
39					10×12.5 32 3000
47		6.3×6.0 60 1400		8×10.5 40 2100	
56	6.3×6.0 50 1400				10×10.5 36 2550
68		6.3×7.7 35 2100	8×10.5 30 2300		10×12.5 32 3000
82			8×10.5 30 2300	10×10.5 30 2600	
100	6.3×7.7 30 2100			10×12.5 22 3400	
120			10×10.5 28 2700		
150		8×10.5 27 2900	10×10.5★ 28 2700 10×12.5 19 3500		
180			10×12.5 19 3500		
220	8×10.5 27 2900				
270		10×10.5 20 3300			
330	10×10.5 20 3300	10×12.5 17 3800			
470	10×12.5 16 3800				

Please refer to page 18 for ripple current frequency coefficients.

★ S type

Case size: φDxL (mm)

ESR(mΩ)max. at 100kHz, 20°C

Rated ripple current
mA rms (100kHz, 125°C)

Part number

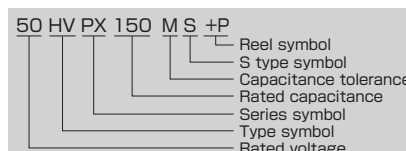
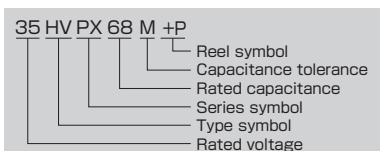

Soldering Condition
Reflow Soldering Condition
Ripple Current Frequency Coefficient

- FVL
- HVHZ-HVH
- HVPZ-HVP
- HVT
- HVHF
- HVPF
- HVPX
- HVTX
- HVHY
- HVPY
- HVTY
- HVHC
- HVPC
- FVC
- FVF
- FVS
- HEHF
- HEPF
- HEPC

HV TX Series

135°C Long Life

High Ripple Current



- 135°C 2,000 to 4,000hours
- Solvent proof (within 2 minutes)
- AEC-Q200

Specifications

Items	Condition	Specifications		
Rated voltage (V)	—	25	35	
Surge voltage (V)	Room temperature	32	44	
Category temperature range (°C)	—	-55 to +135		
Capacitance tolerance (%)	120Hz/20°C	M : ±20		
Dissipation Factor (tan δ)	tanδ (max.) 120Hz/20°C	0.14	0.12	
Leakage current (LC)	μA/after 2minutes (max.), 20°C	0.01CV		
Endurance	135°C rated voltage applied (With the rated ripple current)	Test	4,000hours(φ6.3 × 6.0 2,000hours)	
		ΔC/C	Within ±30% of the initial value	
		tanδ	Less than 200% of the specified value	
		ESR	Less than 200% of the specified value	
		LC	Less than the specified value	

Marking, Dimensions

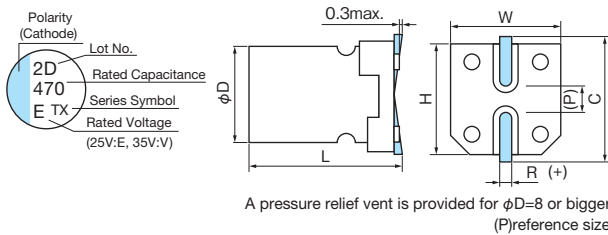

(Unit : mm)

D ^{±0.5}	L ^{±0.3}	W ^{±0.2}	H ^{±0.2}	C ^{±0.2}	R	P
6.3	6.0	6.6	6.6	7.3	0.5 to 0.8	2.2
6.3	7.7	6.6	6.6	7.3	0.5 to 0.8	2.2
8	10.5	8.3	8.3	9.0	0.7 to 1.0	3.2
10	10.5	10.3	10.3	11.0	1.0 to 1.4	4.6
10	12.5	10.3	10.3	11.0	1.0 to 1.4	4.6

Size, ESR, Rated Ripple Current

μF	V	25		35		
		Case size	ESR	Case size	ESR	
47				6.3×6.0	60	900
56		6.3×6.0	50			
68				6.3×7.7	35	1400
100		6.3×7.7	30			
150				8×10.5	27	1600
220		8×10.5	27			
270				10×10.5	20	2000
330		10×10.5	20	10×12.5	17	2260
470		10×12.5	16			

Please refer to page 18 for ripple current frequency coefficients.

Case size: φDxL(mm)

Rated ripple current
mA Arms (100kHz, 135°C)

ESR(mΩ)max. at 100kHz, 20°C

Part number

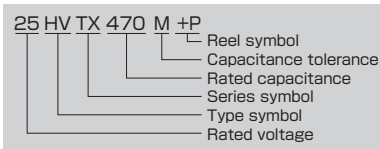

HVHY Series

105°C Long Life

High Ripple Current

- 105°C 10,000hours
- Solvent proof (within 2 minutes)
- AEC-Q200

Specifications

Items	Condition	Specifications		
Rated voltage (V)	—	25	35	
Surge voltage (V)	Room temperature	32	44	
Category temperature range (°C)	—	-55 to +105		
Capacitance tolerance (%)	120Hz/20°C	M : ±20		
Dissipation Factor (tan δ)	tanδ (max.) 120Hz/20°C	0.14	0.12	
Leakage current (LC)	μA/after 2minutes (max.), 20°C	0.01CV		
Endurance	105°C, 10,000hours rated voltage applied (With the rated ripple current)	ΔC/C	Within ±30% of the initial value	
		tanδ	Less than 200% of the specified value	
		ESR	Less than 200% of the specified value	
		LC	Less than the specified value	

Marking, Dimensions

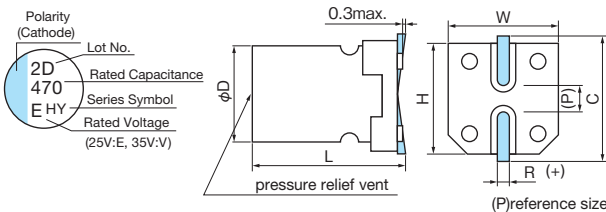

(Unit : mm)

D ^{±0.5}	L ^{±0.3}	W ^{±0.2}	H ^{±0.2}	C ^{±0.2}	R	P
8	10.5	8.3	8.3	9.0	0.7 to 1.0	3.2
10	10.5	10.3	10.3	11.0	1.0 to 1.4	4.6
10	12.5	10.3	10.3	11.0	1.0 to 1.4	4.6

Size, ESR, Rated Ripple Current

μF	V	25			35		
150					8×10.5	20	4500
220		8×10.5	20	4500			
270					10×10.5	18	5000
330		10×10.5	18	5000			
470		10×12.5	14	5500			

Please refer to page 18 for ripple current frequency coefficients.

Case size: φDxL(mm)

Rated ripple current
mA_{rms}(100kHz, 105°C)

ESR(mΩ)max. at 100kHz, 20°C

Part number

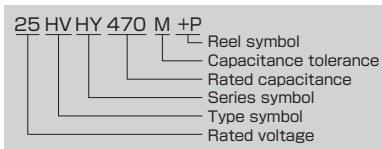

Soldering Condition
Reflow Soldering Condition
Ripple Current Frequency Coefficient

FVL

HVHZ-HVH

HVPZ-HVP

HVT

HVHF

HVPF

HVPX

HVTX

HVHY

HVPY

HVTY

HVHC

HVPC

FVC

FVF

FVS

HEHF

HEPF

HEPC

HVPY Series

125°C

High Ripple Current



- 125°C 4,000hours
- Solvent proof (within 2 minutes)
- AEC-Q200

Specifications

Items	Condition	Specifications	
Rated voltage (V)	—	25	35
Surge voltage (V)	Room temperature	32	44
Category temperature range (°C)	—	-55 to +125	
Capacitance tolerance (%)	120Hz/20°C	M : ±20	
Dissipation Factor (tan δ)	tanδ (max.) 120Hz/20°C	0.14	0.12
Leakage current (LC)	μA/after 2minutes (max.), 20°C	0.01CV	
Endurance	125°C, 4,000hours rated voltage applied (With the rated ripple current)	ΔC/C	Within ±30% of the initial value
		tanδ	Less than 200% of the specified value
		ESR	Less than 200% of the specified value
		LC	Less than the specified value

Marking, Dimensions

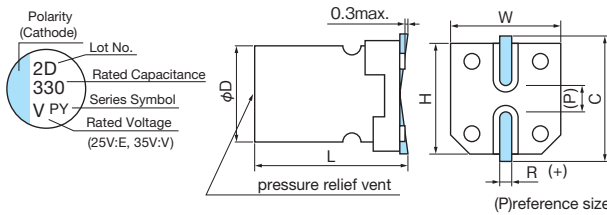

(Unit : mm)

D ^{±0.5}	L ^{±0.3}	W ^{±0.2}	H ^{±0.2}	C ^{±0.2}	R	P
10	10.5	10.3	10.3	11.0	1.0 to 1.4	4.6
10	12.5	10.3	10.3	11.0	1.0 to 1.4	4.6

Size, ESR, Rated Ripple Current

μF \ V	25			35		
270				10×10.5	18	4000
330	10×10.5	18	4000	10×12.5	14	4700
470	10×12.5	14	4700			

Please refer to page 18 for ripple current frequency coefficients.

Case size: φDxL(mm)

Rated ripple current
mA Arms (100kHz, 125°C)

ESR(mΩ)max. at 100kHz, 20°C

Part number

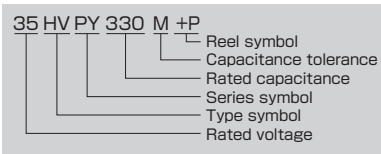

- Soldering Condition
- Reflow Soldering Condition
- Ripple Current Frequency Coefficient
- FVL
- HVHZ-HVH
- HVPZ-HVP
- HVT
- HVHF
- HVPF
- HVPX
- HVTX
- HVHY
- HVPY
- HVTY
- HVHC
- HVPC
- FVC
- FVF
- FVS
- HEHF
- HEPF
- HEPC

HV TY Series

135°C Long Life

High Ripple Current



- 135°C 4,000hours
- Solvent proof (within 2 minutes)
- AEC-Q200

■ Specifications

Items	Condition	Specifications	
Rated voltage (V)	—	25	35
Surge voltage (V)	Room temperature	32	44
Category temperature range (°C)	—	-55 to +135	
Capacitance tolerance (%)	120Hz/20°C	M : ±20	
Dissipation Factor (tan δ)	tanδ (max.) 120Hz/20°C	0.14	0.12
Leakage current (LC)	µA/after 2minutes (max.), 20°C	0.01CV	
Endurance	135°C, 4,000hours rated voltage applied (With the rated ripple current)	ΔC/C	Within ±30% of the initial value
		tanδ	Less than 200% of the specified value
		ESR	Less than 200% of the specified value
		LC	Less than the specified value

Aluminum Electrolytic Capacitors with Hybrid Conductive Polymer

Soldering Condition
Reflow Soldering Condition
Ripple Current Frequency Coefficient

- FVL
- HVHZ-HVH
- HVPZ-HVP
- HVT
- HVHF
- HVPF
- HVPX
- HVTX
- HVHY
- HVPY**
- HV TY**
- HVHC
- HVPC
- FVC
- FVF
- FVS
- HEHF
- HEPF
- HEPC

■ Marking, Dimensions

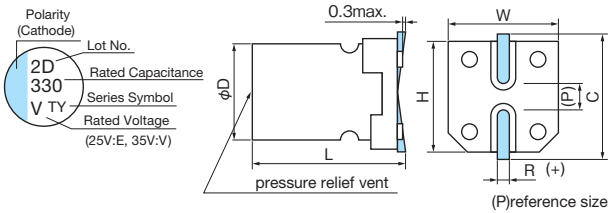

(Unit : mm)

D ^{±0.5}	L ^{±0.3}	W ^{±0.2}	H ^{±0.2}	C ^{±0.2}	R	P
10	10.5	10.3	10.3	11.0	1.0 to 1.4	4.6
10	12.5	10.3	10.3	11.0	1.0 to 1.4	4.6

■ Size, ESR, Rated Ripple Current

µF \ V	25			35		
270				10×10.5	18	2500
330	10×10.5	18	2500	10×12.5	14	2750
470	10×12.5	14	2750			

Please refer to page 18 for ripple current frequency coefficients.

Case size: φDxL(mm) Rated ripple current — mA Arms (100kHz, 135°C)
ESR(mΩ) max. at 100kHz, 20°C

■ Part number

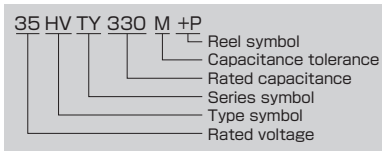

HVHC Series

105°C

High Capacitance

- 105°C 5,000hours
- Solvent proof (within 2 minutes)
- AEC-Q200

Specifications

Items	Condition	Specifications	
Rated voltage (V)	—	25	35
Surge voltage (V)	Room temperature	32	44
Category temperature range (°C)	—	-55 to +105	
Capacitance tolerance (%)	120Hz/20°C	M : ±20	
Dissipation Factor (tan δ)	tanδ (max.) 120Hz/20°C	0.14	0.12
Leakage current (LC)	μA/after 2minutes (max.), 20°C	0.01CV	
Endurance	105°C, 5,000hours rated voltage applied (With the rated ripple current)	ΔC/C	Within ±30% of the initial value
		tanδ	Less than 200% of the specified value
		ESR	Less than 200% of the specified value
		LC	Less than the specified value

Marking, Dimensions

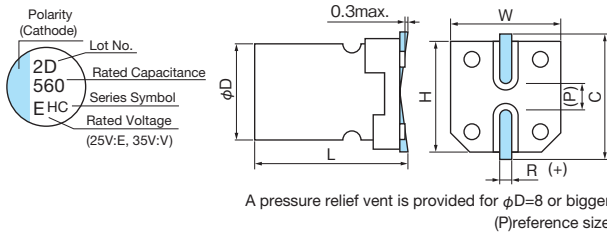

(Unit : mm)

D ^{±0.5}	L ^{±0.3}	W ^{±0.2}	H ^{±0.2}	C ^{±0.2}	R	P
6.3	6.0	6.6	6.6	7.3	0.5 to 0.8	2.2
6.3	7.7	6.6	6.6	7.3	0.5 to 0.8	2.2
8	10.5	8.3	8.3	9.0	0.7 to 1.0	3.2
10	10.5	10.3	10.3	11.0	1.0 to 1.4	4.6
10	12.5	10.3	10.3	11.0	1.0 to 1.4	4.6

Size, ESR, Rated Ripple Current

μF \ V	25		35			
56			6.3×6.0	60	1600	
100	6.3×6.0	50	1600	6.3×7.7	35	2000
150	6.3×7.7	30	2000			
180				8×10.5	27	2550
270	8×10.5	27	2550			
330				10×10.5	20	3500
390				10×12.5	17	4000
470	10×10.5	20	3500			
560	10×12.5	16	4000			

Please refer to page 18 for ripple current frequency coefficients.



Part number

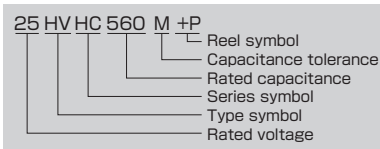

HVPC Series

125°C
High Capacitance



- 125°C 4,000hours
- Solvent proof (within 2 minutes)
- AEC-Q200

■ Specifications

Items	Condition	Specifications		
Rated voltage (V)	—	25	35	
Surge voltage (V)	Room temperature	32	44	
Category temperature range (°C)	—	-55 to +125		
Capacitance tolerance (%)	120Hz/20°C	M : ±20		
Dissipation Factor (tan δ)	tanδ (max.) 120Hz/20°C	0.14	0.12	
Leakage current (LC)	μA/after 2minutes (max.), 20°C	0.01CV		
Endurance	125°C, 4,000hours rated voltage applied (With the rated ripple current)	ΔC/C	Within ±30% of the initial value	
		tanδ	Less than 200% of the specified value	
		ESR	Less than 200% of the specified value	
		LC	Less than the specified value	

Aluminum Electrolytic Capacitors with Hybrid Conductive Polymer

Soldering Condition
Reflow Soldering Condition
Ripple Current Frequency Coefficient

- FVL
- HVHZ-HVH
- HVPZ-HVP
- HVT
- HVHF
- HVPF
- HVPX
- HVTX
- HVHY
- HVPY
- HVTY

- HVHC
- HVPC
- FVC
- FVF
- FVS
- HEHF
- HEPF
- HEPC

■ Marking, Dimensions

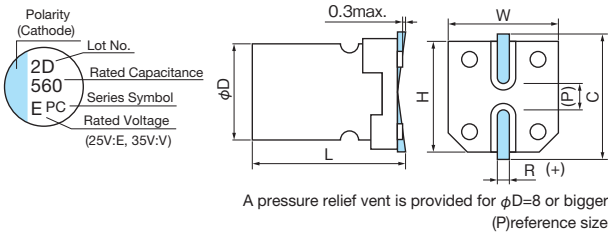

(Unit : mm)

D ^{±0.5}	L ^{±0.3}	W ^{±0.2}	H ^{±0.2}	C ^{±0.2}	R	P
5	6.0	5.3	5.3	6.0	0.5 to 0.8	1.4
6.3	6.0	6.6	6.6	7.3	0.5 to 0.8	2.2
6.3	7.7	6.6	6.6	7.3	0.5 to 0.8	2.2
8	10.5	8.3	8.3	9.0	0.7 to 1.0	3.2
10	10.5	10.3	10.3	11.0	1.0 to 1.4	4.6
10	12.5	10.3	10.3	11.0	1.0 to 1.4	4.6

■ Size, ESR, Rated Ripple Current

μF	V	25		35	
33				5×6.0	100, 750
56	5×6.0	80	850	6.3×6.0	60, 1200
100	6.3×6.0	50	1300	6.3×7.7	35, 1700
150	6.3×7.7	30	1800		
180				8×10.5	27, 2000
270	8×10.5	27	2000		
330				10×10.5	20, 2800
390				10×12.5	17, 3000
470	10×10.5	20	2800		
560	10×12.5	16	3000		

Please refer to page 18 for ripple current frequency coefficients.

Case size: φDxL(mm)

Rated ripple current
mA rms (100kHz, 125°C)
ESR(mΩ) max. at 100kHz, 20°C

■ Part number

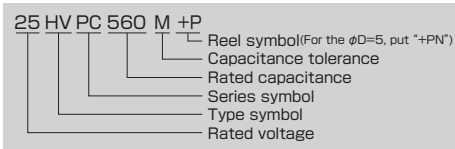

Hybrid Conductive Polymer Type / Surface Mount Type

RoHS compliance

FVC Series

125°C · 135°C
High Capacitance



- 125°C : 4,000hours, 135°C : 4,000hours
- Solvent proof (within 2 minutes)
- AEC-Q200

UP GRADE

Specifications

Items	Condition	Specifications		
Rated voltage (V)	—	25	35	
Surge voltage (V)	Room temperature	32	44	
Category temperature range (°C)	—	-55 to +135		
Capacitance tolerance (%)	120Hz/20°C	M : ±20		
Dissipation Factor (tan δ)	tanδ (max.) 120Hz/20°C	0.14	0.12	
Leakage current (LC)	μA/after 2minutes (max.), 20°C	0.01CV		
Endurance	125°C, 135°C rated voltage applied (With the rated ripple current)	Test	4,000hours	
		ΔC/C	Within ±30% of the initial value	
		tanδ	Less than 200% of the specified value	
		ESR	Less than 200% of the specified value	
		LC	Less than the specified value	

Marking, Dimensions

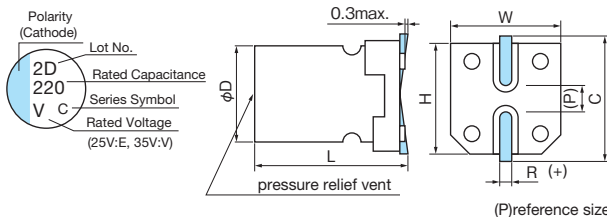

(Unit : mm)						
D ^{±0.5}	L ^{±0.3}	W ^{±0.2}	H ^{±0.2}	C ^{±0.2}	R	P
8	10.5	8.3	8.3	9.0	0.7 to 1.0	3.2
10	10.5	10.3	10.3	11.0	1.0 to 1.4	4.6
10	12.5	10.3	10.3	11.0	1.0 to 1.4	4.6
10	13.8	10.3	10.3	11.0	1.0 to 1.4	4.6
10	16.5	10.3	10.3	11.0	1.0 to 1.4	4.6

Size, ESR, Rated Ripple Current

μF	Items	25				35			
		Case size φDxL (mm)	ESR (mΩmax.) (20°C/100kHz)	Rated ripple current (mA rms/100kHz)		Case size φDxL (mm)	ESR (mΩmax.) (20°C/100kHz)	Rated ripple current (mA rms/100kHz)	
				125°C	135°C			125°C	135°C
220					8x10.5	27	3100	1500	
330		8x10.5	27	3100	1500				
390					10x10.5	20	3600	1750	
470					10x12.5	16	4100	1950	
560		10x10.5	20	3600	1750	10x13.8	15	4300	2050
680		10x12.5	16	4100	1950	10x16.5	11	5200	2500
820		10x13.8	15	4300	2050				
1000		10x16.5	11	5200	2500				

Please refer to page 18 for ripple current frequency coefficients.

Part number

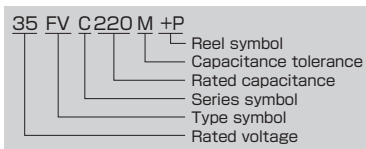

Soldering Condition
Reflow Soldering Condition
Ripple Current Frequency Coefficient
FVL
HVHZ-HVH
HVPZ-HVP
HVT
HVHF
HVPF
HVPX
HVTX
HVHY
HVPY
HVTY
HVHC
HVPC
FVC
FVF
FVS
HEHF
HEPF
HEPC

FVF Series

150°C Long Life

High Ripple Current



- 125°C 4,000hours, 135°C 4,000hours, 150°C 4,000hours
- Solvent proof (within 2 minutes)
- AEC-Q200

Specifications

Items	Condition	Specifications					
Rated voltage (V)	—	25	35	50	63	80	
Surge voltage (V)	Room temperature	32	44	63	79	100	
Category temperature range (°C)	—	$\phi D=6.3$: -40 to +135 $\phi D \geq 8$: -40 to +150					
Capacitance tolerance (%)	120Hz/20°C	M: ± 20					
Dissipation Factor (tan δ)	tan δ (max.) 120Hz/20°C	0.14	0.12	0.10	0.08	0.08	
Leakage current (LC)	μA /after 2minutes (max.), 20°C	0.01CV					
Endurance	150°C rated voltage applied (With the rated ripple current)	Test	4,000hours				
		$\Delta C/C$	Within $\pm 35\%$ of the initial value				
		tan δ	Less than 200% of the specified value				
		ESR	Less than 250% of the specified value				
		LC	Less than the specified value				
	125°C, 135°C rated voltage applied (With the rated ripple current)	Test	4,000hours				
		$\Delta C/C$	Within $\pm 30\%$ of the initial value				
		tan δ	Less than 200% of the specified value				
		ESR	Less than 200% of the specified value				
		LC	Less than the specified value				

Marking, Dimensions

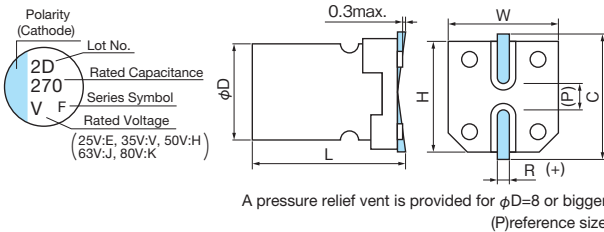

(Unit : mm)

D ± 0.5	L ± 0.3	W ± 0.2	H ± 0.2	C ± 0.2	R	P
6.3	7.7	6.6	6.6	7.3	0.5 to 0.8	2.2
8	10.5	8.3	8.3	9.0	0.7 to 1.0	3.2
10	10.5	10.3	10.3	11.0	1.0 to 1.4	4.6
10	12.5	10.3	10.3	11.0	1.0 to 1.4	4.6
10	13.8	10.3	10.3	11.0	1.0 to 1.4	4.6
10	16.5	10.3	10.3	11.0	1.0 to 1.4	4.6

Size, ESR, Rated Ripple Current

V Items μF	25						35					50				
	Case size $\phi D \times L$ (mm)	ESR (m Ω max.) (20°C/100kHz)	Rated ripple current (mA r_{ms} /100kHz)			Case size $\phi D \times L$ (mm)	ESR (m Ω max.) (20°C/100kHz)	Rated ripple current (mA r_{ms} /100kHz)			Case size $\phi D \times L$ (mm)	ESR (m Ω max.) (20°C/100kHz)	Rated ripple current (mA r_{ms} /100kHz)			
			125°C	135°C	150°C			125°C	135°C	150°C			125°C	135°C	150°C	
33																
68					6.3x7.7		35	2700	1800	—						
100	6.3x7.7	30	2700	1800	—						6.3x7.7	40	2200	1500	—	
120											8x10.5	30	2900	2100	1100	
150											10x10.5	28	3600	2600	1400	
180											10x12.5	19	3900	2800	1600	
220	8x10.5	20	3500	2500	1200						10x13.8	18	4400	3100	1800	
270											10x16.5	13	5100	3700	2100	
330	10x10.5	18	4000	3100	1600	10x10.5	18	4000	3100	1600						
360						10x12.5	14	4700	3400	1800						
470	10x12.5	14	4700	3400	1800	10x13.8	13	5200	3700	2000						
560	10x13.8	13	5200	3700	2000	10x16.5	11	5700	4100	2250						
680	10x16.5	11	5700	4100	2250											

V 項目 μF	63						80									
	Case size $\phi D \times L$ (mm)	ESR (m Ω max.) (20°C/100kHz)	Rated ripple current (mA r_{ms} /100kHz)			Case size $\phi D \times L$ (mm)	ESR (m Ω max.) (20°C/100kHz)	Rated ripple current (mA r_{ms} /100kHz)								
			125°C	135°C	150°C			125°C	135°C	150°C						
22	6.3x7.7	60	2000	1400	—											
33						8x10.5	45	2500	1700	900						
47	8x10.5	40	2700	1900	1000											
56	8x10.5	40	2700	1900	1000	10x10.5	36	3200	2200	1100						
68						10x12.5	32	3500	2400	1300						
82	10x10.5	30	3400	2400	1250	10x13.8	28	3900	2600	1500						
100	10x10.5★	30	3400	2400	1250	10x16.5	16	4400	3200	1800						
	10x12.5	22	3700	2600	1450											
120	10x12.5★	22	3700	2600	1450											
	10x13.8	20	4100	2800	1700											
150	10x13.8★	20	4100	2800	1700											
	10x16.5	15	4900	3500	2000											
180	10x16.5	15	4900	3500	2000											

Please refer to page 18 for ripple current frequency coefficients.
★S type

Part number

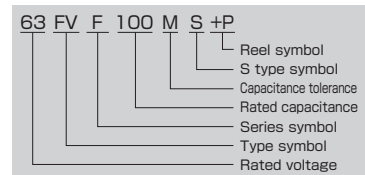
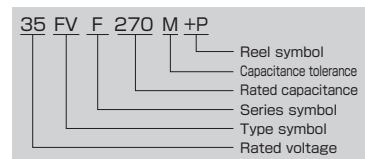

FVS Series

125°C

-16V Proof



- 125°C 4,000hours
- Reverse polarity proof(-16V, 60 minutes)
- Solvent proof (within 2 minutes)
- AEC-Q200

Specifications

Items	Condition	Specifications	
Rated voltage (V)	-	35	
Surge voltage (V)	Room temperature	44	
Category temperature range (°C)	-	-55 to +125	
Capacitance tolerance (%)	120Hz/20°C	M : ±20	
Dissipation Factor (tan δ)	tanδ (max.) 120Hz/20°C	0.12	
Leakage current (LC)	μA/after 2minutes (max.), 20°C	0.01CV	
Endurance	125°C, 4,000hours rated voltage applied (With the rated ripple current)	ΔC/C	Within ±30% of the initial value
		tanδ	Less than 200% of the specified value
		ESR	Less than 200% of the specified value
		LC	Less than the specified value

Marking, Dimensions

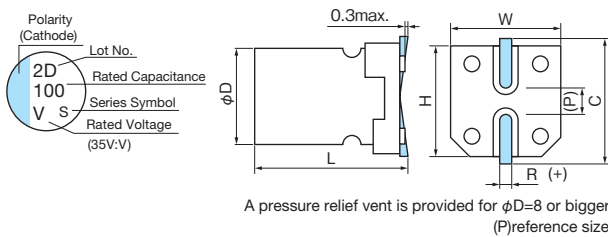

(Unit : mm)

D ^{±0.5}	L ^{±0.3}	W ^{±0.2}	H ^{±0.2}	C ^{±0.2}	R	P
6.3	7.7	6.6	6.6	7.3	0.5 to 0.8	2.2
8	10.5	8.3	8.3	9.0	0.7 to 1.0	3.2
10	10.5	10.3	10.3	11.0	1.0 to 1.4	4.6
10	12.5	10.3	10.3	11.0	1.0 to 1.4	4.6

Size, ESR, Rated Ripple Current

Items μF	Case size φDxL (mm)	ESR (mΩmax.) (20°C/100kHz)	35	
			Rated ripple current (mA rms/100kHz)	125°C
47	6.3x7.7	35		1400
100	8x10.5	27		1600
150	10x10.5	20		2000
220	10x12.5	17		2260

Please refer to page 18 for ripple current frequency coefficients.

Part number

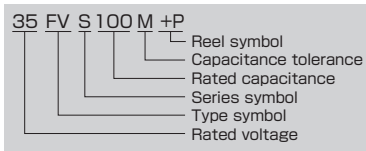

Soldering Condition
Reflow Soldering Condition
Ripple Current Frequency Coefficient
FVL
HVHZ-HVH
HVPZ-HVP
HVT
HVHF
HVPF
HVPX
HVTX
HVHY
HVPY
HVTY
HVHC
HVPC
FVC
FVF
FVS
HEHF
HEPF
HEPC

HEHF Series

105°C Long Life

High Capacitance

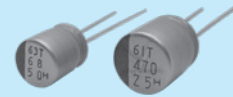

- 105°C 10,000hours ● Laminated case
- Solvent proof (within 2 minutes)
- AEC-Q200

■ Specifications

Items	Condition	Specifications					
Rated voltage (V)	—	25	35	50	63	80	100
Surge voltage (V)	Room temperature	32	44	63	79	100	125
Category temperature range (°C)	—	-55 to +105					
Capacitance tolerance (%)	120Hz/20°C	M : ±20					
Dissipation Factor(tan δ)	tanδ (max.) 120Hz/20°C	0.14	0.12	0.10	0.08	0.08	0.08
Leakage current (LC)	μA/after 2minutes (max.), 20°C	The greater value of either 0.05CV or 100					
Endurance	105°C, 10,000hours rated voltage applied (With the rated ripple current)	ΔC/C	Within ±30% of the initial value				
		tanδ	Less than 200% of the specified value				
		ESR	Less than 200% of the specified value				
		LC	Less than the specified value				

■ Marking, Dimensions

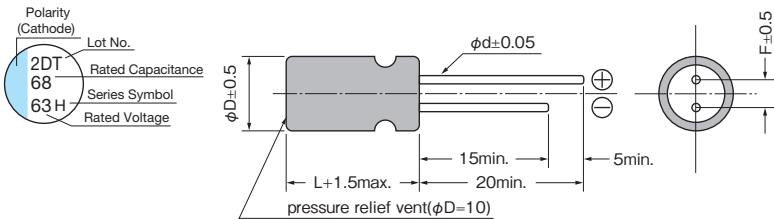

(Unit : mm)

φD	L	F	φd
6.3	7.2	2.5	0.45
8	9.5	3.5	0.6
10	9.5	5.0	0.7
10	11.5	5.0	0.7

■ Size, ESR, Rated Ripple Current

μF \ V	25	35	50	63	80	100
10						8×9.5 60 1400
15				6.3×7.2 80 1500		10×9.5 45 1500
18						10×11.5 40 1580
22				6.3×7.2 80 1500	8×9.5 45 1550	
27					8×9.5 45 1550	
33			6.3×7.2 40 1600	8×9.5 40 1700	10×9.5 36 1700	
39					10×11.5 32 1800	
47				8×9.5 40 1700	10×9.5 36 1700	
56				10×9.5 30 1800	10×11.5 32 1800	
68		6.3×7.2 35 2000	8×9.5 30 1800	10×11.5 22 2100		
82				10×9.5 30 1800		
100	6.3×7.2 30 2000			10×11.5 22 2100		
120			10×9.5 28 2000			
150		8×9.5 27 2300	10×11.5 19 2300			
220	8×9.5 27 2300					
270		10×9.5 20 2500				
330	10×9.5 20 2500	10×11.5 17 2800				
470	10×11.5 16 2800					

Please refer to page 18 for ripple current frequency coefficients.

Case size: φD×L(mm) ESR(mΩ) max. at 100kHz, 20°C
 Rated ripple current mArms(100kHz, 105°C)

■ Part number

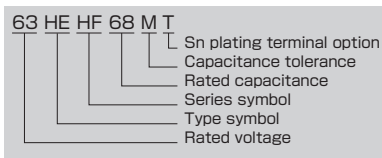

Soldering Condition
 Reflow Soldering Condition
 Ripple Current Frequency Coefficient

- FVL
- HVHZ-HVH
- HVPZ-HVP
- HVT
- HVHF
- HVPF
- HVPX
- HVTX
- HVHY
- HVPY
- HVTY
- HVHC
- HVPC
- FVC
- FVF
- FVS
- HEHF
- HEPF
- HEPC

HEPF Series

125°C

High Capacitance

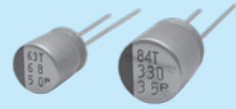

- 125°C 4,000hours ● Laminated case
- Solvent proof (within 2 minutes)
- AEC-Q200

Specifications

Items	Condition	Specifications					
Rated voltage (V)	—	25	35	50	63	80	100
Surge voltage (V)	Room temperature	32	44	63	79	100	125
Category temperature range (°C)	—	-55 to +125					
Capacitance tolerance (%)	120Hz/20°C	M : ±20					
Dissipation Factor (tan δ)	tanδ (max.) 120Hz/20°C	0.14	0.12	0.10	0.08	0.08	0.08
Leakage current (LC)	μA/after 2minutes (max.), 20°C	The greater value of either 0.05CV or 100					
Endurance	125°C, 4,000hours rated voltage applied (With the rated ripple current)	ΔC/C	Within ±30% of the initial value				
		tanδ	Less than 200% of the specified value				
		ESR	Less than 200% of the specified value				
		LC	Less than the specified value				

Marking, Dimensions

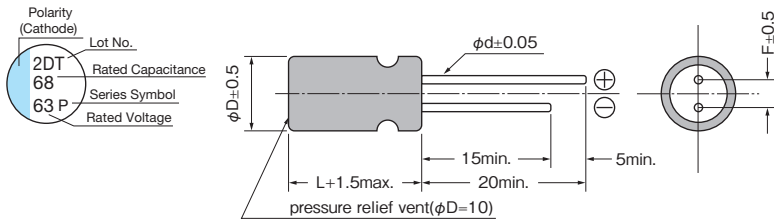

(Unit : mm)

φD	L	F	φd
6.3	7.2	2.5	0.45
8	9.5	3.5	0.6
10	9.5	5.0	0.7
10	11.5	5.0	0.7

Size, ESR, Rated Ripple Current

μF	V	25	35	50	63	80	100
10							8×9.5 60 900
15					6.3×7.2 80 900		10×9.5 45 1120
18							10×11.5 40 1220
22					6.3×7.2 80 900	8×9.5 45 1030	
27						8×9.5 45 1030	
33				6.3×7.2 40 1100	8×9.5 40 1100	10×9.5 36 1270	
39						10×11.5 32 1360	
47					8×9.5 40 1100	10×9.5 36 1270	
56					10×9.5 30 1400	10×11.5 32 1360	
68			6.3×7.2 35 1400	8×9.5 30 1250	10×11.5 22 1650		
82					10×9.5 30 1400		
100	6.3×7.2	30 1400			10×11.5 22 1650		
120				10×9.5 28 1600			
150			8×9.5 27 1600	10×11.5 19 1820			
220	8×9.5	27 1600					
270			10×9.5 20 2000				
330	10×9.5	20 2000	10×11.5 17 2260				
470	10×11.5	16 2260					

Please refer to page 18 for ripple current frequency coefficients.

Case size: φDxL (mm) ———
 ESR (mΩ) ———
 max. at 100kHz, 20°C
 Rated ripple current ———
 mA rms (100kHz, 125°C)

Part number

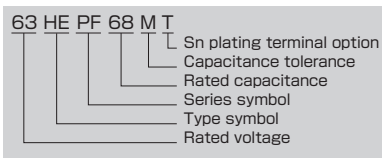

HEPC Series

125°C

High Capacitance

- 125°C 4,000hours ● Laminated case
- Solvent proof (within 2 minutes)
- AEC-Q200

■ Specifications

Items	Condition	Specifications		
Rated voltage (V)	—	25	35	
Surge voltage (V)	Room temperature	32	44	
Category temperature range (°C)	—	-55 to +125		
Capacitance tolerance (%)	120Hz/20°C	M : ±20		
Dissipation Factor (tan δ)	tanδ (max.) 120Hz/20°C	0.14	0.12	
Leakage current (LC)	μA/after 2minutes (max.), 20°C	0.05CV		
Endurance	125°C, 4,000hours rated voltage applied (With the rated ripple current)	ΔC/C	Within ±30% of the initial value	
		tanδ	Less than 200% of the specified value	
		ESR	Less than 200% of the specified value	
		LC	Less than the specified value	

■ Marking, Dimensions

φD	L	F	φd
6.3	7.2	2.5	0.45
8	9.5	3.5	0.6
10	9.5	5.0	0.7
10	11.5	5.0	0.7

■ Size, ESR, Rated Ripple Current

μF	V	25			35		
		Case size	ESR (mΩ)	Rated ripple current	Case size	ESR (mΩ)	Rated ripple current
100							
150		6.3x7.2	30	1800	6.3x7.2	35	1700
180					8x9.5	27	2000
270		8x9.5	27	2000			
330					10x9.5	20	2800
390					10x11.5	17	3000
470		10x9.5	20	2800			
560		10x11.5	16	3000			

Please refer to page 18 for ripple current frequency coefficients.

Case size: φDxL (mm) ESR (mΩ) max. at 100kHz, 20°C Rated ripple current mA rms (100kHz, 125°C)

■ Part number

25 HE PC 560 M T

- 25: Rated voltage
- HE: Type symbol
- PC: Series symbol
- 560: Rated capacitance
- M: Capacitance tolerance
- T: Sn plating terminal option

Aluminum Electrolytic Capacitors with Hybrid Conductive Polymer

Soldering Condition
Reflow Soldering Condition
Ripple Current Frequency Coefficient

- FVL
- HVHZ-HVH
- HVPZ-HVP
- HVT
- HVHF
- HVPF
- HVPX
- HVTX
- HVHY
- HVPY
- HVTY
- HVHC
- HVPC
- FVC
- FVF
- FVS
- HEHF
- HEPF
- HEPC

Aluminum Electrolytic Capacitors

Aluminum electrolytic capacitors are hard to be a short-circuit since the self-healing mechanism of the dielectric (aluminum oxide layer). Aluminum electrolytic capacitors carry high voltage and high capacitance with reasonable prices.

CE-LD

CE-FSS

CE-FS(High Voltage)

CE-FS

CE-AX

CE-ZX

CE-ZC

CE-LX

CE-GA

CE-LS

CE-LH

CE-LH(High Voltage)

CE-LL

CE-LF

CE-PC

CE-PH

CE-PS

CE-PF

CE-TH

CE-JX

CE-FN

ME-SZ

ME-SAX

ME-SWG

ME-LS

ME-CZ

ME-CA

ME-CX

ME-AX

ME-WX

ME-WA

ME-WL

ME-WG

ME-FX

ME-FC·FD

ME-FH

ME-SWN

ME-HWN

Features

- Wide voltage range 6.3V to 450V.
- Wide capacitance range 0.47 μ F to 15000 μ F.
- Self-healing mechanism of the dielectric. (aluminum oxide layer)
- Hard to be a short-circuit. The primary failure mode is wear-out.
- The capacitance does not change by voltage.
- Strong to a pulse current and a pulse voltage as compared with the other type of capacitors.

Applications

Automotive electronics, Network equipments, Industrial equipments, Digital equipments, Consumer electronics, personal computers, signal processing, back-up use, etc.

CE-LD Series

Long Life

4.5mm Height



- 105°C 3,000hours
- Solvent proof (within 2 minutes)
- AEC-Q200

Specifications

Items	Condition	Specifications						
Rated voltage (V)	—	6.3	10	16	25	35	50	
Surge voltage (V)	Room temperature	8.0	13	20	32	44	63	
Category temperature range (°C)	—	-40 to +105						
Capacitance tolerance (%)	120Hz/20°C	M : ±20						
Dissipation Factor(tan δ)	tanδ (max.) 120Hz/20°C	0.35	0.30	0.20	0.16	0.14	0.12	
Leakage current (LC)	μA/after 2minutes (max.), 20°C	The greater value of either 0.01CV or 3						
Impedance ratio at low temperature	Based on the value at 120Hz, +20°C	-25°C	Z/Z _{20°C}	4	3	2	2	2
		-40°C	Z/Z _{20°C}	10	8	6	4	4
Endurance	105°C, 3,000hours rated voltage applied (With the rated ripple current)	ΔC/C	Within ±30% of the initial value					
		tanδ	Less than 300% of the specified value					
		LC	Less than the specified value					

CE-LD

CE-FSS
CE-FS(High Voltage)
CE-FS
CE-AX
CE-ZX
CE-ZC
CE-LX
CE-GA
CE-LS
CE-LH
CE-LH(High Voltage)
CE-LL
CE-LF
CE-PC
CE-PH
CE-PS
CE-PF
CE-TH
CE-JX
CE-FN

Marking, Dimensions

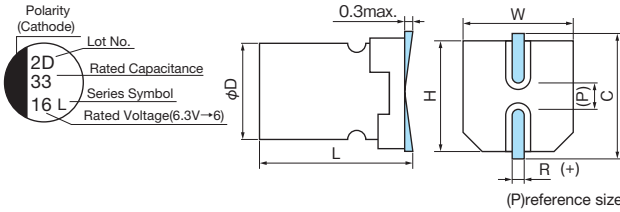

(Unit : mm)

D ^{±0.5}	L ^{+0.1 -0.2}	W ^{±0.2}	H ^{±0.2}	C ^{±0.2}	R	P
6.3	4.5	6.6	6.6	7.3	0.5 to 0.8	2.2

Size, Rated Ripple Current

μF \ V	6.3	10	16	25	35	50
10						6.3×4.5 24
22				6.3×4.5 33	6.3×4.5 35	
33			6.3×4.5 36	6.3×4.5 40		
47		6.3×4.5 38	6.3×4.5 43	6.3×4.5 44		
100	6.3×4.5 49	6.3×4.5 52				

Please refer to page 14 for ripple current frequency coefficients.

Case size: φD×L(mm)

 Rated ripple current
mA_{rms}(120Hz, 105°C)

Part number

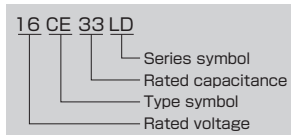

CE-FSS Series

Small, High Capacitance

5.4mm Height

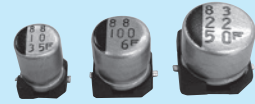

- 105°C 1,000hours
- Solvent proof (within 2 minutes)
- AEC-Q200

Specifications

Items	Condition	Specifications							
Rated voltage (V)	—	6.3	10	16	25	35	50		
Surge voltage (V)	Room temperature	8.0	13	20	32	44	63		
Category temperature range (°C)	—	-40 to +105							
Capacitance tolerance (%)	120Hz/20°C	M : ±20							
Dissipation Factor (tan δ)	tanδ (max.) 120Hz/20°C	0.35	0.30	0.26	0.20	0.16	0.12		
Leakage current (LC)	μA/after 2minutes (max.), 20°C	The greater value of either 0.01CV or 3							
Impedance ratio at low temperature	Based on the value at 120Hz, +20°C	-25°C Z/Z _{20°C}	4	3	2	2	2	2	
		-40°C Z/Z _{20°C}	10	8	6	4	4	4	
Endurance	105°C, 1,000hours rated voltage applied (With the rated ripple current)	ΔC/C	Within ±25% of the initial value(6.3V:±30%)						
		tanδ	Less than 300% of the specified value						
		LC	Less than the specified value						

Marking, Dimensions

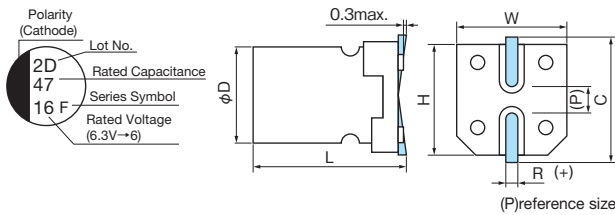

(Unit : mm)

D ^{±0.5}	L ^{+0.1 -0.2}	W ^{±0.2}	H ^{±0.2}	C ^{±0.2}	R	P
4	5.4	4.3	4.3	5.0	0.5 to 0.8	1.0
5	5.4	5.3	5.3	6.0	0.5 to 0.8	1.4
6.3	5.4	6.6	6.6	7.3	0.5 to 0.8	2.2

Size, Rated Ripple Current

μF \ V	6.3	10	16	25	35	50
4.7						4x5.4 16
10				4x5.4 22	4x5.4 22	5x5.4 23
22		4x5.4 28	4x5.4 28	5x5.4 35	5x5.4 35	6.3x5.4 35
33	4x5.4 29	4x5.4 29	5x5.4 35	5x5.4 45	6.3x5.4 42	
47	4x5.4 36	5x5.4 43	5x5.4 39	6.3x5.4 70		
100	5x5.4 47	5x5.4 47				
150	6.3x5.4 71	6.3x5.4 71				
220	6.3x5.4 74					

Please refer to page 14 for ripple current frequency coefficients.

Case size: φDxL(mm)

Rated ripple current
mA Arms (120Hz, 105°C)

Part number

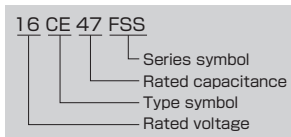

- Aluminum Electrolytic Capacitors
- Surface Mount Type
- CE-LD
- CE-FSS
- CE-FS(High Voltage)
- CE-FS
- CE-AX
- CE-ZX
- CE-ZC
- CE-LX
- CE-GA
- CE-LS
- CE-LH
- CE-LH(High Voltage)
- CE-LL
- CE-LF
- CE-PC
- CE-PH
- CE-PS
- CE-PF
- CE-TH
- CE-JX
- CE-FN

CE-FS Series

105°C Standard

High Voltage



- 160 to 400V, 105°C 1,000 to 2,000hours
- Non solvent proof
- AEC-Q200

Specifications

Items	Condition	Specifications				
Rated voltage (V)	—	160	200	250	400	
Surge voltage (V)	Room temperature	200	250	300	450	
Category temperature range (°C)	—	-40 to +105				
Capacitance tolerance (%)	120Hz/20°C	M : ±20				
Dissipation Factor (tan δ)	tanδ (max.) 120Hz/20°C	0.20			0.25	
Leakage current (LC)	μA/after 2minutes (max.) (20°C)	CV ≤ 1000	0.03CV + 15			
		CV > 1000	0.02CV + 25			
Impedance ratio at low temperature	Based on the value at 120Hz, +20°C	-25°C Z/Z _{20°C}	3	3	3	6
		-40°C Z/Z _{20°C}	6	6	6	10
Endurance	105°C rated voltage applied (With the rated ripple current)	Test	φ8 : 1,000hours, φ10 to φ16 : 2,000hours			
		ΔC/C	Within ±25% of the initial value			
		tanδ	Less than 200% of the specified value			
		LC	Less than the specified value			

Marking, Dimensions

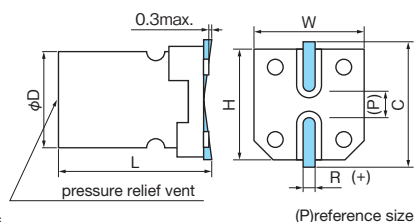
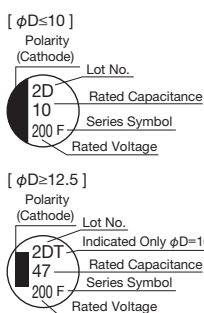

(Unit : mm)

D ^{+0.5}	L ^{+0.3}	W ^{+0.2}	H ^{+0.2}	C ^{+0.2}	R	P
8	10.5	8.3	8.3	9.0	0.7 to 1.0	3.2
10	10.5	10.3	10.3	11.0	1.0 to 1.4	4.6
12.5	13.5 ^{+0.5}	12.8	12.8	13.5	1.0 to 1.4	4.6
16	16.5 ^{+0.5}	16.3	16.3	17.3	1.7 to 2.1	7.0

Size, Rated Ripple Current

μF \ V	160	200	250	400
2.2				8×10.5 25
3.3			8×10.5 31	10×10.5 36
4.7			8×10.5 37	10×10.5 38
6.8			8×10.5 44	12.5×13.5 47
10	8×10.5 57	10×10.5 64	10×10.5 64	12.5×13.5 57
22	12.5×13.5 112	12.5×13.5 112	12.5×13.5 112	16×16.5 115
33	12.5×13.5 137	12.5×13.5 137	16×16.5 150	
47	16×16.5 180	16×16.5 180	16×16.5 180	
68	16×16.5 215	16×16.5 215		
82	16×16.5 235			

Please refer to page 14 for ripple current frequency coefficients.

 Case size: φDXL (mm)
16×16.5:CE-FST

 Rated ripple current
mA rms (120Hz, 105°C)

Part number

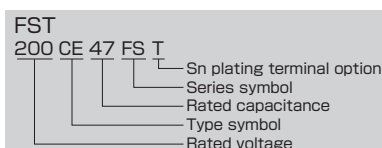
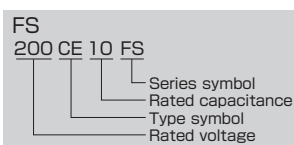

CE-FS Series

105°C Standard



- 105°C 1,000 to 2,000hours
- Solvent proof (within 2 minutes)
- AEC-Q200

Specifications

Items	Condition	Specifications								
Rated voltage (V)	—	6.3	10	16	25	35	50	63	100	
Surge voltage (V)	Room temperature	8.0	13	20	32	44	63	79	125	
Category temperature range (°C)	—	-55 to +105							-40 to +105	
Capacitance tolerance (%)	120Hz/20°C	M : ±20								
Dissipation Factor (tan δ)	tanδ(max.) 120Hz/20°C	φ4 to φ6.3	0.24	0.20	0.16	0.14	0.12	0.10	0.12	0.10
		φ8 to φ16	0.28	0.24	0.20	0.16	0.14	0.12	0.12	0.10
		φ18	0.34	0.30	0.26	0.22	0.18	0.16	0.14	0.10
Leakage current(LC)	μA/after 2minutes (max.), 20°C	Exceeding 1,000μF, +0.02 every 1,000μF								
Impedance ratio at low temperature	Based on the value at 120Hz, +20°C	-40°C Z/Z _{20°C}	3	3	2	2	2	2	2	3
		-55°C Z/Z _{20°C}	8	5	4	3	3	3	3	—
Endurance	105°C rated voltage applied (With the rated ripple current)	Test	φ4 to φ6.3 : 1,000hours, φ8 to φ18 : 2,000hours							
		ΔC/C	Within ±25% of the initial value							
		tanδ	Less than 200% of the specified value							
		LC	Less than the specified value							

Marking, Dimensions

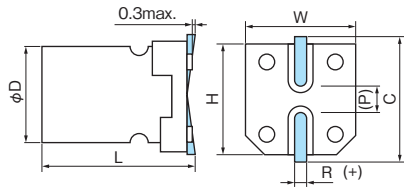
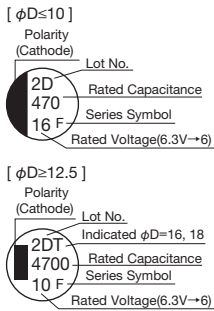

A pressure relief vent is provided for φD=8 or bigger

(P)reference size

(Unit : mm)

D ^{±0.5}	L	W ^{±0.2}	H ^{±0.2}	C ^{±0.2}	R	P
4	5.4 ^{+0.1} _{-0.2}	4.3	4.3	5.0	0.5 to 0.8	1.0
4	6.0 ^{±0.3}	4.3	4.3	5.0	0.5 to 0.8	1.0
5	5.4 ^{+0.1} _{-0.2}	5.3	5.3	6.0	0.5 to 0.8	1.4
6.3	5.4 ^{+0.1} _{-0.2}	6.6	6.6	7.3	0.5 to 0.8	2.2
6.3	6.0 ^{±0.3}	6.6	6.6	7.3	0.5 to 0.8	2.2
6.3	7.7 ^{±0.3}	6.6	6.6	7.3	0.5 to 0.8	2.2
8	10.2 ^{±0.3}	8.3	8.3	9.0	0.7 to 1.0	3.2
10	10.2 ^{±0.3}	10.3	10.3	11.0	1.0 to 1.4	4.6
12.5	13.5 ^{±0.5}	12.8	12.8	13.5	1.0 to 1.4	4.6
16	16.5 ^{±0.5}	16.3	16.3	17.3	1.7 to 2.1	7.0
18	16.5 ^{±1.0}	19.0	19.0	20.0	1.7 to 2.1	7.0
18	21.5 ^{±1.0}	19.0	19.0	20.0	1.7 to 2.1	7.0

■ Size, Rated Ripple Current

μF \ V	6.3		10		16		25		35	
4.7							4x5.4	13	4x5.4	14
10					4x5.4	18	5x5.4	20	5x5.4	21
22	4x5.4	22	5x5.4	25	5x5.4	27	6.3x5.4	36	6.3x5.4	38
33	5x5.4	27	5x5.4	30	6.3x5.4	40	6.3x5.4	44	6.3x6.0	42
47	5x5.4	33	6.3x5.4	41	6.3x5.4	48	6.3x6.0	48	6.3x6.0	49
100	6.3x5.4	50	6.3x5.4	53	6.3x5.4	60	6.3x7.7	91	6.3x7.7	84
150			6.3x6.0	62	6.3x7.7	95	8x10.2	140	8x10.2	155
220	6.3x6.0	67	6.3x7.7	105	6.3x7.7	105	8x10.2	175	8x10.2	190
330	6.3x7.7	105	8x10.2	195	8x10.2	195	8x10.2	220	10x10.2	300
470	8x10.2	210	8x10.2	210	8x10.2	230	10x10.2	300	12.5x13.5	410
680	8x10.2	210			10x10.2	310			12.5x13.5	430
1000	8x10.2	230	10x10.2	310			12.5x13.5	460	16x16.5	700
1500	10x10.2	310			12.5x13.5	500			16x16.5	740
2200			12.5x13.5	510			16x16.5	805	18x16.5	950
2700									18x21.5	1200
3300	12.5x13.5	520			16x16.5	840	18x16.5	1040		
3900							18x21.5	1280		
4700			16x16.5	880	18x16.5	1090				
5600					18x21.5	1300				
6800	16x16.5	930	18x16.5	1150						
8200			18x21.5	1350						
10000	18x16.5	1200								
12000	18x21.5	1350								

μF \ V	50		63		100	
0.47	4x5.4	3.5	4x5.4	3.5		
1.0	4x5.4	7.0	4x5.4	7.0	4x6.0	7.0
2.2	4x5.4	11	4x5.4	11	6.3x6.0	14
3.3	4x5.4	13	5x5.4	14	6.3x6.0	20
4.7	5x5.4	16	5x5.4	16	6.3x6.0	25
10	6.3x5.4	24	6.3x5.4	24	6.3x7.7	35
22	6.3x6.0	42	6.3x7.7	49	8x10.2	84
33	6.3x7.7	60	8x10.2	112	10x10.2	133
47	6.3x7.7	63	8x10.2	119	12.5x13.5	240
68			8x10.2	126	12.5x13.5	245
100	8x10.2	140	10x10.2	196	16x16.5	490
150					16x16.5	500
220	10x10.2	220	12.5x13.5	287	18x16.5	650
330	12.5x13.5	365			18x21.5	700
390	12.5x13.5	380				
470			16x16.5	630		
680			18x16.5	750		
1000	16x16.5	655	18x21.5	900		
1500	18x21.5	1100				

Please refer to page 14 for ripple current frequency coefficients.

Case size: φDxL(mm)
φ16, φ18:CE-FST

Rated ripple current
mA_{rms}(120Hz, 105°C)

■ Part number

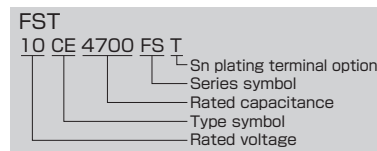
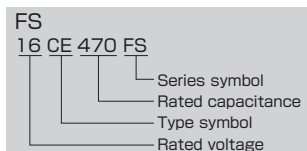

CE-AX Series

Low Impedance



- 105°C 1,000 to 2,000hours ● We recommend CE-LX series on page 48.
- Solvent proof (within 2 minutes)
- AEC-Q200

Specifications

Items	Condition	Specifications						
Rated voltage (V)	—	6.3	10	16	25	35	50	
Surge voltage (V)	Room temperature	8.0	13	20	32	44	63	
Category temperature range (°C)	—	-55 to +105						
Capacitance tolerance (%)	120Hz/20°C	M : ±20						
Dissipation Factor (tan δ)	tanδ(max.) 120Hz/20°C	φ4 to φ6.3	0.24	0.20	0.16	0.14	0.12	0.12
		φ8 to φ16	0.28	0.24	0.20	0.16	0.14	0.14
Leakage current(LC)	μA/after 2minutes (max.), 20°C	Exceeding 1,000μF, +0.02 every 1,000μF						
Impedance ratio at low temperature	Based on the value at 120Hz, +20°C	-40°C Z/Z _{20°C}	3	2	2	2	2	2
		-55°C Z/Z _{20°C}	5	4	4	3	3	3
Endurance	105°C rated voltage applied (With the rated ripple current)	Test	φ4 to φ6.3 : 1,000hours, φ8 to φ16 : 2,000hours					
		ΔC/C	Within ±25% of the initial value					
		tanδ	Less than 200% of the specified value					
		LC	Less than the specified value					

Marking, Dimensions

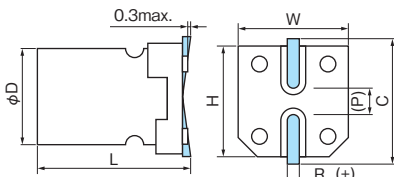
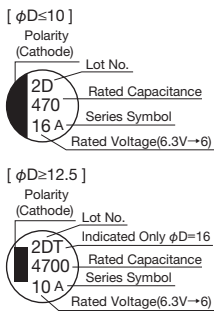

A pressure relief vent is provided for φD=8 or bigger

(P)reference size

(Unit : mm)

D ^{±0.5}	L ^{±0.3}	W ^{±0.2}	H ^{±0.2}	C ^{±0.2}	R	P
4	6.0	4.3	4.3	5.0	0.5 to 0.8	1.0
5	6.0	5.3	5.3	6.0	0.5 to 0.8	1.4
6.3	6.0	6.6	6.6	7.3	0.5 to 0.8	2.2
6.3	7.7	6.6	6.6	7.3	0.5 to 0.8	2.2
8	10.2	8.3	8.3	9.0	0.7 to 1.0	3.2
10	10.2	10.3	10.3	11.0	1.0 to 1.4	4.6
12.5	13.5 ^{±0.5}	12.8	12.8	13.5	1.0 to 1.4	4.6
16	16.5 ^{±0.5}	16.3	16.3	17.3	1.7 to 2.1	7.0

- CE-LD
- CE-FSS
- CE-FS(High Voltage)
- CE-FS
- CE-AX**
- CE-ZX
- CE-ZC
- CE-LX
- CE-GA
- CE-LS
- CE-LH
- CE-LH(High Voltage)
- CE-LL
- CE-LF
- CE-PC
- CE-PH
- CE-PS
- CE-PF
- CE-TH
- CE-JX
- CE-FN

■ Size, Impedance, Rated Ripple Current

μF \ V	6.3			10			16			25			35			50		
4.7													4x6.0	1.80	80	4x6.0	2.90	60
10										4x6.0	1.80	80	5x6.0	0.76	150	6.3x6.0	0.88	165
15							4x6.0	1.80	80	5x6.0	0.76	150	5x6.0	0.76	150			
22				4x6.0	1.80	80	5x6.0	0.76	150	5x6.0	0.76	150	5x6.0	0.76	150	6.3x6.0	0.88	165
27	4x6.0	1.80	80															
33	→			5x6.0	0.76	150	→			6.3x6.0	0.44	230	6.3x6.0	0.44	230	6.3x7.7	0.68	195
47	5x6.0	0.76	150	→			6.3x6.0	0.44	230	6.3x6.0	0.44	230	6.3x6.0	0.44	230	6.3x7.7	0.68	195
56	5x6.0	0.76	150							6.3x6.0	0.44	230						
68	→			6.3x6.0	0.44	230	6.3x6.0	0.44	230	6.3x6.0	0.44	230	6.3x7.7	0.34	280			
100	6.3x6.0	0.44	230	→			6.3x6.0	0.44	230	6.3x7.7	0.34	280	8x10.2	0.17	450	8x10.2	0.39	300
150	6.3x6.0	0.44	230	6.3x6.0	0.44	230	6.3x7.7	0.34	280	8x10.2	0.17	450	8x10.2	0.17	450	10x10.2	0.21	450
220	6.3x6.0	0.44	230	6.3x7.7	0.34	280	6.3x7.7	0.34	280	8x10.2	0.17	450	8x10.2	0.17	450	10x10.2	0.21	450
330	6.3x7.7	0.34	280	8x10.2	0.17	450	8x10.2	0.17	450	8x10.2	0.17	450	10x10.2	0.090	670	12.5x13.5	0.14	620
390																12.5x13.5	0.14	620
470	8x10.2	0.17	450	8x10.2	0.17	450	8x10.2	0.17	450	10x10.2	0.090	670	12.5x13.5	0.066	900			
680	8x10.2	0.17	450	→			10x10.2	0.090	670				12.5x13.5	0.066	900			
1000	8x10.2	0.17	450	10x10.2	0.090	670				12.5x13.5	0.066	900				16x16.5	0.078	790
1500	10x10.2	0.090	670				12.5x13.5	0.066	900				16x16.5	0.052	1250			
2200				12.5x13.5	0.066	900				16x16.5	0.052	1250						
3300	12.5x13.5	0.066	900				16x16.5	0.052	1250									
4700				16x16.5	0.052	1250												
6800	16x16.5	0.052	1250															

→Please use the higher voltage model in the next.
Please refer to page 14 for ripple current frequency coefficients.

Case size: $\phi D \times L$ (mm)
16x16.5:CE-AXT

Rated ripple current
mA rms (100kHz, 105°C)

Impedance(Ω)
max. at 100kHz, 20°C

■ Part number

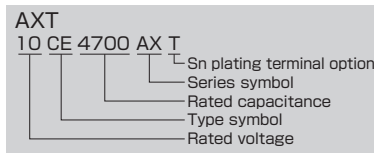
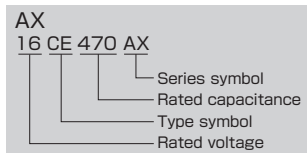

CE-ZX Series

Super Low ESR



- 30 to 50% less ESR than CE-KX series at high frequencies.
- 105°C 2,000hours ● Solvent proof (within 2 minutes)
- AEC-Q200

Specifications

Items	Condition	Specifications					
Rated voltage (V)	—	6.3	10	16	25	35	50
Surge voltage (V)	Room temperature	8.0	13	20	32	44	63
Category temperature range (°C)	—	-55 to +105					
Capacitance tolerance (%)	120Hz/20°C	M : ±20					
Dissipation Factor (tan δ)	tanδ (max.) 120Hz/20°C	0.26	0.19	0.16	0.14	0.12	0.10
Leakage current (LC)	µA/after 2minutes (max.), 20°C	0.01CV					
Impedance ratio at low temperature	Based on the value at 120Hz, +20°C	-40°C Z/Z _{20°C}	3	3	3	3	3
		-55°C Z/Z _{20°C}	4	4	4	3	3
Endurance	105°C, 2,000hours rated voltage applied (With the rated ripple current)	△C/C	Within ±30% of the initial value				
		tanδ	Less than 200% of the specified value				
		LC	Less than the specified value				

Marking, Dimensions

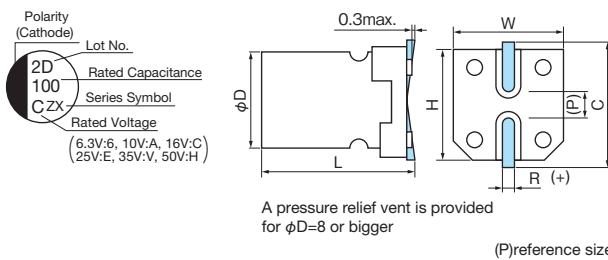

(Unit : mm)

D ^{+0.5}	L ^{+0.3}	W ^{+0.2}	H ^{+0.2}	C ^{+0.2}	R	P
6.3	6.0	6.6	6.6	7.3	0.5 to 0.8	2.2
6.3	7.7	6.6	6.6	7.3	0.5 to 0.8	2.2
8	10.5	8.3	8.3	9.0	0.7 to 1.0	3.2
10	10.5	10.3	10.3	11.0	1.0 to 1.4	4.6
10	13.5 ^{+0.5}	10.3	10.3	11.0	1.0 to 1.4	4.6

Size, ESR, Rated Ripple Current

µF \ V	6.3	10	16	25	35	50
33				6.3x6.0 0.26 300	6.3x6.0 0.26 300	
47			6.3x6.0 0.26 300	6.3x6.0 0.26 300	6.3x6.0 0.26 300	
68			6.3x6.0 0.26 300	6.3x6.0 0.26 300	6.3x7.7 0.16 600	
100	6.3x6.0 0.26 300		6.3x6.0 ★1 0.26 300	6.3x7.7 0.16 600	6.3x7.7 ★1 0.16 600	
150		6.3x6.0 0.26 300	6.3x7.7 0.16 600	8x10.5 0.08 850	8x10.5 0.08 850	
220	6.3x6.0 0.26 300	6.3x7.7 0.16 600	6.3x7.7 0.16 600	8x10.5 0.08 850	8x10.5 0.08 850	10x10.5 0.12 900
330	6.3x7.7 0.16 600	8x10.5 0.08 850	8x10.5 0.08 850	8x10.5 0.08 850	10x10.5 0.06 1190	10x13.5 ★2 0.10 900
390					10x10.5 0.08 850	
470	8x10.5 0.08 850	8x10.5 0.08 850	8x10.5 0.08 850	10x10.5 0.06 1190	10x13.5 ★2 0.06 1190	
560				10x10.5 0.08 850		
680		8x10.5 0.08 850	10x10.5 0.06 1190	10x13.5 ★2 0.06 1190		
820			10x10.5 0.08 850			
1000	8x10.5 0.08 850	10x10.5 0.06 1190	10x13.5 ★2 0.06 1190			
1200		10x10.5 0.08 850				
1500	10x10.5 0.06 1190	10x13.5 ★2 0.06 1190				
1800	10x10.5 0.08 850					

Please refer to page 14 for ripple current frequency coefficients.
★1 ZXS ★2 ZXC

Case size: φDxL(mm)

Rated ripple current
mA_{rms}(100kHz, 105°C)
ESR(Ω)
max. at 100kHz, 20°C

Part number

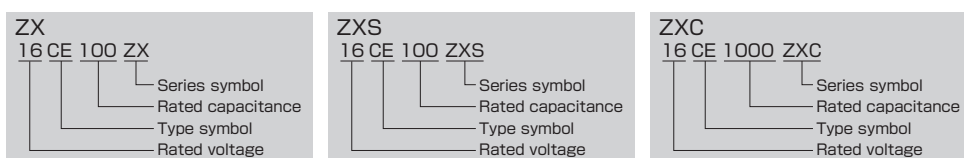

CE-ZC Series

Super Low ESR

Small, High Capacitance



UP GRADE

- 105°C 2,000 to 3,000hours
- Solvent proof (within 2 minutes)
- AEC-Q200

Surface Mount Type
Aluminum Electrolytic Capacitors

- CE-LD
- CE-FSS
- CE-FS(High Voltage)
- CE-FS
- CE-AX
- CE-ZX
- CE-ZC
- CE-LX
- CE-GA
- CE-LS
- CE-LH
- CE-LH(High Voltage)
- CE-LL
- CE-LF
- CE-PC
- CE-PH
- CE-PS
- CE-PF
- CE-TH
- CE-JX
- CE-FN

Specifications

Items	Condition	Specifications						
Rated voltage (V)	—	6.3	10	16	25	35	50	
Surge voltage (V)	Room temperature	8	13	20	32	44	63	
Category temperature range (°C)	—	-55 to +105						
Capacitance tolerance (%)	120Hz/20°C	M : ±20						
Dissipation Factor(tan δ)	tanδ (max.) 120Hz/20°C	0.26	0.19	0.16	0.14	0.12	0.10	
		Exceeding 1,000µF, +0.02 every 1,000µF						
Leakage current(LC)	µA/after 2minutes (max.), 20°C	0.01CV						
Impedance ratio at low temperature	Based on the value at 120Hz, +20°C	-40°C Z/Z _{20°C}	3	3	3	3	3	3
		-55°C Z/Z _{20°C}	4	4	4	3	3	3
Endurance	105°C rated voltage applied (With the rated ripple current)	Test	2,000hours(φ10 × 13.5 3,000hours)					
		ΔC/C	Within ±30% of the initial value					
		tanδ	Less than 200% of the specified value					
		LC	Less than the specified value					

Marking, Dimensions

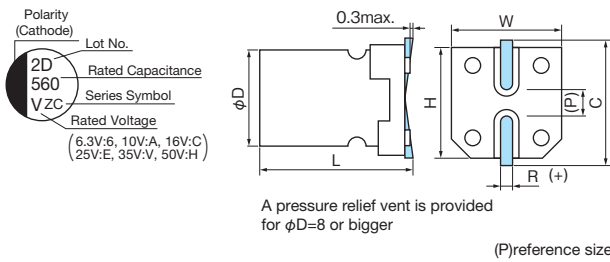

(Unit : mm)

D ^{±0.5}	L ^{±0.3}	W ^{±0.2}	H ^{±0.2}	C ^{±0.2}	R	P
6.3	6.0	6.6	6.6	7.3	0.5 to 0.8	2.2
6.3	7.7	6.6	6.6	7.3	0.5 to 0.8	2.2
8	10.5	8.3	8.3	9.0	0.7 to 1.0	3.2
10	10.5	10.3	10.3	11.0	1.0 to 1.4	4.6
10	13.5 ^{±0.5}	10.3	10.3	11.0	1.0 to 1.4	4.6

Size, ESR, Rated Ripple Current

µF \ V	6.3	10	16	25	35	50
47						6.3×6.0 0.68 195
68					6.3×6.0 0.28 300	
100				6.3×6.0 0.28 300	6.3×6.0 0.28 300	
150			6.3×6.0 0.28 300	6.3×7.7 0.16 600	6.3×7.7 0.16 600	
220		6.3×6.0 0.28 300	6.3×6.0 0.28 300	6.3×7.7 0.16 600		
330	6.3×6.0 0.28 300	6.3×7.7 0.16 600	6.3×7.7 0.16 600		8×10.5 0.08 850	10×10.5 0.12 900
390					8×10.5 0.08 850	
470	6.3×7.7 0.16 600	6.3×7.7 0.16 600		8×10.5 0.08 850	10×10.5 0.06 1190	
560				8×10.5 0.08 850	10×10.5 0.06 1190	
680	6.3×7.7 0.16 600		8×10.5 0.08 850		10×10.5 0.06 1190	
820				10×10.5 0.06 1190	10×13.5★ 0.06 1500	
1000		8×10.5 0.08 850	10×10.5 0.06 1190	10×10.5 0.06 1190		
1200				10×13.5★ 0.06 1500		
1500	8×10.5 0.08 850	10×10.5 0.06 1190				
2200	10×10.5 0.06 1190					

Please refer to page 14 for ripple current frequency coefficients.

★ ZCC

Case size: φD×L(mm)

ESR(Ω)
max. at 100kHz, 20°C

Rated ripple current
mA Arms(100kHz, 105°C)

Part number

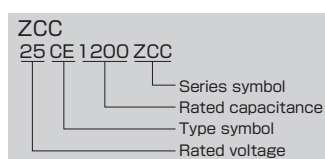
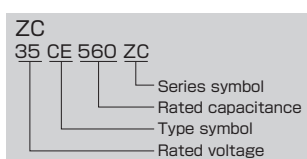

CE-LX Series

Long Life

Low Impedance



- 105°C 2,000 to 5,000hours
- Solvent proof (within 2 minutes)
- AEC-Q200

Specifications

Items	Condition	Specifications									
Rated voltage (V)	—	6.3	10	16	25	35	50	63	80	100	
Surge voltage (V)	Room temperature	8.0	13	20	32	44	63	79	100	125	
Category temperature range (°C)	—	-55 to +105									
Capacitance tolerance (%)	120Hz/20°C	M : ±20									
Dissipation Factor (tan δ)	tanδ(max.) 120Hz/20°C	φ4 to φ6.3	0.26	0.20	0.16	0.14	0.12	0.12	0.08	—	—
		φ8 to φ18	0.28	0.24	0.22	0.16	0.14	0.14	0.08	0.08	0.07
Leakage current (LC)	μA/after 2minutes (max.), 20°C	Exceeding 1,000μF, +0.02 every 1,000μF The greater value of either 0.01CV or 3									
Impedance ratio at low temperature	Based on the value at 120Hz, +20°C	-40°C Z/Z _{20°C}	3	3	3	3	3	3	2	2	2
		-55°C Z/Z _{20°C}	4	4	4	3	3	3	3	3	3
Endurance	105°C rated voltage applied (With the rated ripple current)	Test	φ4 to φ6.3 : 2,000hours, φ8 to φ18 : 5,000hours								
		ΔC/C	Within ±30% of the initial value								
		tanδ	Less than 300% of the specified value								
		LC	Less than the specified value								

Marking, Dimensions

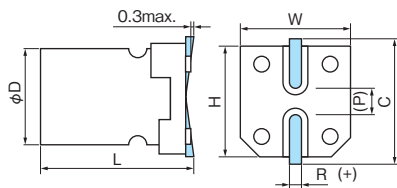
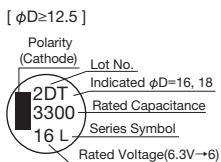
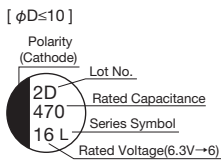

A pressure relief vent is provided for φD=8 or bigger

(P)reference size

(Unit : mm)

D ^{±0.5}	L ^{±0.3}	W ^{±0.2}	H ^{±0.2}	C ^{±0.2}	R	P
4	6.0	4.3	4.3	5.0	0.5 to 0.8	1.0
5	6.0	5.3	5.3	6.0	0.5 to 0.8	1.4
6.3	6.0	6.6	6.6	7.3	0.5 to 0.8	2.2
6.3	7.7	6.6	6.6	7.3	0.5 to 0.8	2.2
8	10.2	8.3	8.3	9.0	0.7 to 1.0	3.2
10	10.2	10.3	10.3	11.0	1.0 to 1.4	4.6
10	13.5 ^{±0.5}	10.3	10.3	11.0	1.0 to 1.4	4.6
12.5	13.5 ^{±0.5}	12.8	12.8	13.5	1.0 to 1.4	4.6
16	16.5 ^{±0.5}	16.3	16.3	17.3	1.7 to 2.1	7.0
18	16.5 ^{±1.0}	19.0	19.0	20.0	1.7 to 2.1	7.0
18	21.5 ^{±1.0}	19.0	19.0	20.0	1.7 to 2.1	7.0

Part number

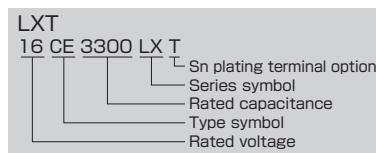
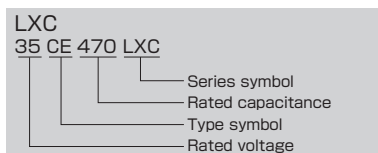
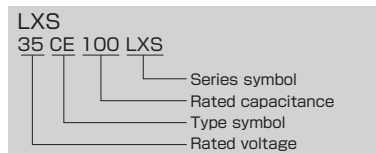
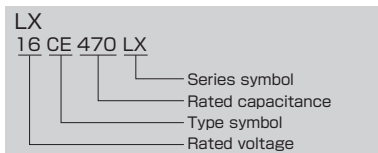

CE-GA Series

Low Impedance

5.4mm Height



- 105°C 1,000hours
- Solvent proof (within 2 minutes)
- AEC-Q200

Specifications

Items	Condition	Specifications							
Rated voltage (V)	—	6.3	10	16	25	35	50	63	
Surge voltage (V)	Room temperature	8.0	13	20	32	44	63	79	
Category temperature range (°C)	—	-55 to +105							
Capacitance tolerance (%)	120Hz/20°C	M : ±20							
Dissipation Factor (tan δ)	tanδ (max.) 120Hz/20°C	0.24	0.20	0.16	0.14	0.12	0.12	0.12	
Leakage current (LC)	μA/after 2minutes (max.), 20°C	The greater value of either 0.01CV or 3							
Impedance ratio at low temperature	Based on the value at 120Hz, +20°C	-40°C Z/Z _{20°C}	3	2	2	2	2	2	2
		-55°C Z/Z _{20°C}	5	4	4	3	3	3	3
Endurance	105°C, 1,000hours rated voltage applied (With the rated ripple current)	ΔC/C	Within ±25% of the initial value						
		tanδ	Less than 200% of the specified value						
		LC	Less than the specified value						

Marking, Dimensions

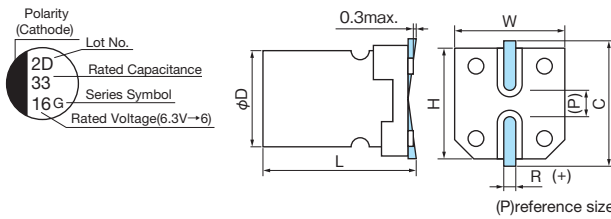

(Unit : mm)

D ^{±0.5}	L ^{+0.1 -0.2}	W ^{±0.2}	H ^{±0.2}	C ^{±0.2}	R	P
4	5.4	4.3	4.3	5.0	0.5 to 0.8	1.0
5	5.4	5.3	5.3	6.0	0.5 to 0.8	1.4
6.3	5.4	6.6	6.6	7.3	0.5 to 0.8	2.2

Size, Impedance, Rated Ripple Current

μF \ V	6.3	10	16	25	35	50	63
1.0					4	3.1	68
2.2					4	2.9	68
3.3					4	2.7	68
4.7				4	2.3	68	5
10			4	2.3	68	5	1.1
22	4	2.3	68	5	1.1	105	6.3
33	5	1.1	105	5	1.1	105	6.3
47	5	1.1	105	6.3	0.6	155	6.3
100	6.3	0.6	155	6.3	0.6	155	6.3
220	6.3	0.6	155	6.3	0.6	155	6.3

Please refer to page 14 for ripple current frequency coefficients.

Impedance(Ω)
max. at 100kHz, 20°C
Case size:φD(mm)

Rated ripple current
mA rms(100kHz, 105°C)

Part number

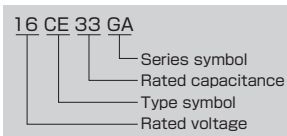

CE-LS Series

Long Life

Low Impedance



- 105°C 3,000hours
- Solvent proof (within 2 minutes)
- AEC-Q200

Specifications

Items	Condition	Specifications						
Rated voltage (V)	—	6.3	10	16	25	35	50	
Surge voltage (V)	Room temperature	8.0	13	20	32	44	63	
Category temperature range (°C)	—	-40 to +105						
Capacitance tolerance (%)	120Hz/20°C	M : ±20						
Dissipation Factor (tan δ)	tanδ (max.) 120Hz/20°C	0.28	0.24	0.22	0.16	0.13	0.12	
Leakage current (LC)	μA/after 2minutes (max.), 20°C	The greater value of either 0.01CV or 3						
Impedance ratio at low temperature	Based on the value at 120Hz, +20°C	-25°C	Z/Z _{20°C}	4	3	2	2	2
		-40°C	Z/Z _{20°C}	10	7	5	3	3
Endurance	105°C, 3,000hours rated voltage applied (With the rated ripple current)	ΔC/C	Within ±30% of the initial value					
		tanδ	Less than 300% of the specified value					
		LC	Less than the specified value					

Marking, Dimensions

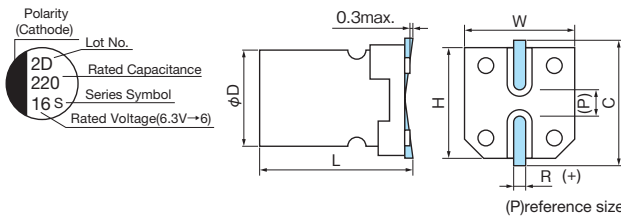

(Unit : mm)

D ^{+0.5}	L ^{+0.3}	W ^{+0.2}	H ^{+0.2}	C ^{+0.2}	R	P
5	6.0	5.3	5.3	6.0	0.5 to 0.8	1.4
6.3	6.0	6.6	6.6	7.3	0.5 to 0.8	2.2
6.3	7.7	6.6	6.6	7.3	0.5 to 0.8	2.2

Size, Impedance, Rated Ripple Current

μF \ V	6.3	10	16	25	35	50
10					5×6.0 1.30 95	6.3×6.0 2.00 70
22			5×6.0 1.30 95	5×6.0 1.30 95	6.3×6.0 0.70 140	6.3×6.0 2.00 70
33		5×6.0 1.30 95		6.3×6.0 0.70 140		6.3×7.7 1.35 100
47	5×6.0 1.30 95	5×6.0 1.30 95	6.3×6.0 0.70 140	6.3×6.0 0.70 140	6.3×7.7 0.60 230	
100	6.3×6.0 0.70 140	6.3×6.0 0.70 140	6.3×6.0 0.70 140	6.3×7.7 0.60 230		
150		6.3×6.0 0.70 140	6.3×7.7 0.60 230			
220	6.3×7.7 0.60 230		6.3×7.7 0.60 230			
330	6.3×7.7 0.60 230					

Please refer to page 14 for ripple current frequency coefficients.

 Impedance(Ω) max. at 100kHz, 20°C
 Rated ripple current mAmps(100kHz, 105°C)
 Case size:φDxL(mm)

Part number

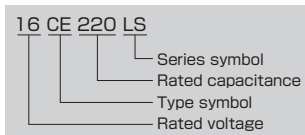

CE-LH Series

Long Life



- 105°C 5,000hours
- Solvent proof (within 2 minutes)
- AEC-Q200

Specifications

Items	Condition	Specifications						
Rated voltage (V)	—	6.3	10	16	25	35	50	
Surge voltage (V)	Room temperature	8.0	13	20	32	44	63	
Category temperature range (°C)	—	-40 to +105						
Capacitance tolerance (%)	120Hz/20°C	M : ±20						
Dissipation Factor (tan δ)	tanδ (max.) 120Hz/20°C	0.32	0.24	0.20	0.16	0.13	0.12	
Leakage current (LC)	μA/after 2minutes (max.), 20°C	The greater value of either 0.01CV or 3						
Impedance ratio at low temperature	Based on the value at 120Hz, +20°C	-25°C Z/Z _{20°C}	4	3	2	2	2	2
		-40°C Z/Z _{20°C}	10	7	5	3	3	3
Endurance	105°C, 5,000hours rated voltage applied (With the rated ripple current)	ΔC/C	Within ±30% of the initial value					
		tanδ	Less than 300% of the specified value					
		LC	Less than the specified value					

Marking, Dimensions

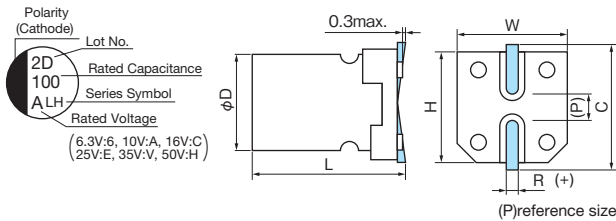

(Unit : mm)

D ^{±0.5}	L ^{±0.3}	W ^{±0.2}	H ^{±0.2}	C ^{±0.2}	R	P
4	6.0	4.3	4.3	5.0	0.5 to 0.8	1.0
5	6.0	5.3	5.3	6.0	0.5 to 0.8	1.4
6.3	6.0	6.6	6.6	7.3	0.5 to 0.8	2.2
6.3	7.7	6.6	6.6	7.3	0.5 to 0.8	2.2

Size, Rated Ripple Current

μF \ V	6.3	10	16	25	35	50
1.0						4×6.0 6.2
2.2						4×6.0 11
3.3						4×6.0 14
4.7					4×6.0 15	5×6.0 19
10			4×6.0 18	5×6.0 25	5×6.0 25	6.3×6.0 30
22		5×6.0 30	5×6.0 30	6.3×6.0 42	6.3×6.0 42	6.3×7.7 49
33	5×6.0 35	5×6.0 35	6.3×6.0 48	6.3×6.0 48	6.3×7.7 57	
47	5×6.0 36	6.3×6.0 50	6.3×6.0 50	6.3×7.7 63		
100	6.3×6.0 60	6.3×7.7 81	6.3×7.7 81			
220	6.3×7.7 101					

Please refer to page 14 for ripple current frequency coefficients.

Case size: φDxL (mm)

Rated ripple current
mA Arms (120Hz, 105°C)

Part number

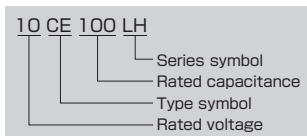

CE-LH Series

105°C Long Life

High Voltage



- 160 to 400V, 105°C 5,000hours
- Non solvent proof
- AEC-Q200

Specifications

Items	Condition	Specifications			
Rated voltage (V)	—	160	200	400	
Surge voltage (V)	Room temperature	200	250	450	
Category temperature range (°C)	—	-40 to +105			
Capacitance tolerance (%)	120Hz/20°C	M : ±20			
Dissipation Factor (tan δ)	tanδ (max.) 120Hz/20°C	0.20	0.20	0.25	
Leakage current (LC)	μA/after 2minutes (max.) (20°C)	CV ≤ 1,000	0.03CV + 15		
		CV > 1,000	0.02CV + 25		
Impedance ratio at low temperature	Based on the value at 120Hz, +20°C	-25°C Z/Z _{20°C}	3	3	6
		-40°C Z/Z _{20°C}	6	6	10
Endurance	105°C, 5,000hours rated voltage applied (With the rated ripple current)	ΔC/C	Within ±30% of the initial value		
		tanδ	Less than 300% of the specified value		
		LC	Less than the specified value		

 Surface Mount Type
 Aluminum Electrolytic Capacitors

 CE-LD
 CE-FSS
 CE-FS(High Voltage)
 CE-FS
 CE-AX
 CE-ZX
 CE-ZC
 CE-LX
 CE-GA
 CE-LS
CE-LH
 CE-LH(High Voltage)
 CE-LL
 CE-LF
 CE-PC
 CE-PH
 CE-PS
 CE-PF
 CE-TH
 CE-JX
 CE-FN

Marking, Dimensions

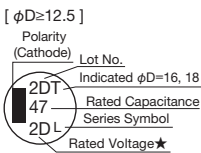
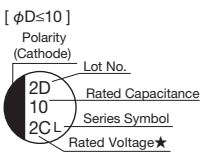

★(160V : 2C, 200V : 2D, 400V : 2G)

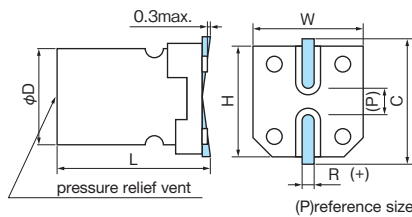

(Unit : mm)

D ^{±0.5}	L	W ^{±0.2}	H ^{±0.2}	C ^{±0.2}	R	P
8	10.5 ^{±0.3}	8.3	8.3	9.0	0.7 to 1.0	3.2
10	10.5 ^{±0.3}	10.3	10.3	11.0	1.0 to 1.4	4.6
12.5	13.5 ^{±0.5}	12.8	12.8	13.5	1.0 to 1.4	4.6
16	16.5 ^{±0.5}	16.3	16.3	17.3	1.7 to 2.1	7.0
18	16.5 ^{±1.0}	19.0	19.0	20.0	1.7 to 2.1	7.0
18	21.5 ^{±1.0}	19.0	19.0	20.0	1.7 to 2.1	7.0

Size, Rated Ripple Current

μF \ V	160	200	400
2.2			8×10.5 25
3.3		8×10.5 31	10×10.5 36
4.7		8×10.5 37	10×10.5 38
10	10×10.5 43	10×10.5 43	12.5×13.5 57
22	12.5×13.5 112	12.5×13.5 112	16×16.5 115
27			18×16.5 125
33	12.5×13.5 137	12.5×13.5 137	18×21.5 160
47	16×16.5 180	16×16.5 180	
68	16×16.5 215	16×16.5 215	
		18×16.5 ★ 270	
82	16×16.5 235		
100	18×16.5 320	18×21.5 330	
120	18×21.5 340		

Please refer to page 14 for ripple current frequency coefficients.

★LHV

 Case size: φD×L (mm)
 φ16, φ18: CE-LHT

 Rated ripple current
 mA Arms (120Hz, 105°C)

Part number

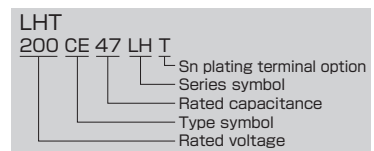
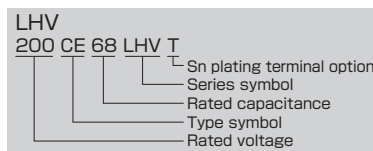
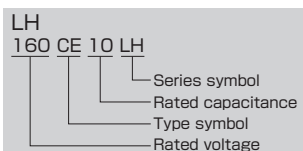

CE-LL Series

Long Life

Low Impedance



- 105°C 7,000 to 10,000hours
- Solvent proof (within 2 minutes)
- AEC-Q200

Specifications

Items	Condition	Specifications					
Rated voltage (V)	—	6.3	10	16	25	35	50
Surge voltage (V)	Room temperature	8.0	13	20	32	44	63
Category temperature range (°C)	—	-40 to +105					
Capacitance tolerance (%)	120Hz/20°C	M : ±20					
Dissipation Factor (tan δ)	tanδ (max.) 120Hz/20°C	0.32	0.28	0.26	0.16	0.14	0.14
Leakage current (LC)	μA/after 2minutes (max.), 20°C	The greater value of either 0.01CV or 3					
Impedance ratio at low temperature	Based on the value at 120Hz, +20°C	-25°C	Z/Z _{20°C}	4	3	2	2
Endurance	105°C rated voltage applied (With the rated ripple current)	Test	φD ≤ 6.3 : 7,000hours, φD ≥ 8 : 10,000hours				
		ΔC/C	Within ±30% of the initial value				
		tanδ	Less than 300% of the specified value				
		LC	Less than the specified value				

Marking, Dimensions

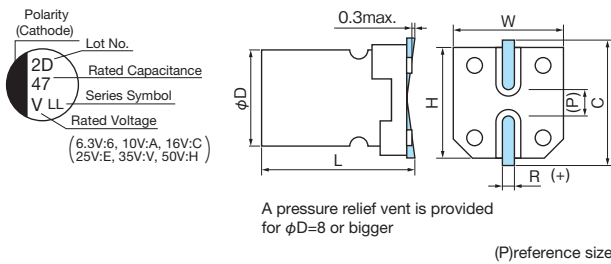

(Unit : mm)

D ^{±0.5}	L ^{±0.3}	W ^{±0.2}	H ^{±0.2}	C ^{±0.2}	R	P
5	7.0	5.3	5.3	6.0	0.5 to 0.8	1.4
6.3	7.0	6.6	6.6	7.3	0.5 to 0.8	2.2
6.3	8.4	6.6	6.6	7.3	0.5 to 0.8	2.2
8	10.2	8.3	8.3	9.0	0.7 to 1.0	3.2
10	10.2	10.3	10.3	11.0	1.0 to 1.4	4.6

Size, Impedance, Rated Ripple Current

μF \ V	6.3	10	16	25	35	50
10					5×7.0 2.2 95	
22			5×7.0 2.2 95	5×7.0 2.2 95	5×7.0 2.2 95	6.3×8.4 1.8 100
33		5×7.0 2.2 95		6.3×7.0 1.1 140	6.3×8.4 1.0 230	8×10.2 0.53 350
47	5×7.0 2.2 95		6.3×7.0 1.1 140	6.3×7.0 1.1 140	6.3×8.4 1.0 230	8×10.2 0.53 350
100	6.3×7.0 1.1 140		6.3×7.0 1.1 140	6.3×8.4 1.0 230	8×10.2 0.22 600	10×10.2 0.35 670
150		6.3×7.0 1.1 140	6.3×8.4 1.0 230	8×10.2 0.22 600		
220	6.3×8.4 1.0 230		6.3×8.4 1.0 230	8×10.2 0.22 600	10×10.2 0.16 850	
330	6.3×8.4 1.0 230		8×10.2 0.22 600	10×10.2 0.16 850		
470	8×10.2 0.22 600		10×10.2 0.16 850			
1000	10×10.2 0.16 850					

Please refer to page 14 for ripple current frequency coefficients.

Impedance(Ω) max. at 100kHz, 20°C

Rated ripple current mArms(100kHz, 105°C)

Case size: φDxL(mm)

Part number

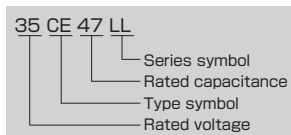

CE-LF Series

Long Life
Low Impedance



- 105°C 7,000hours
- Solvent proof (within 2 minutes)
- AEC-Q200

Specifications

Items	Condition	Specifications					
Rated voltage (V)	—	16	25	35	50		
Surge voltage (V)	Room temperature	20	32	44	63		
Category temperature range (°C)	—	-40 to +105					
Capacitance tolerance (%)	120Hz/20°C	M : ±20					
Dissipation Factor (tan δ)	tanδ (max.) 120Hz/20°C	0.26	0.16	0.14	0.14		
Leakage current (LC)	μA/after 2minutes (max.), 20°C	0.01CV					
Impedance ratio at low temperature	Based on the value at 120Hz, +20°C	-25°C	Z/Z _{20°C}	2	2	2	2
Endurance	105°C, 7,000hours rated voltage applied (With the rated ripple current)	ΔC/C	Within ±30% of the initial value				
		tanδ	Less than 300% of the specified value				
		LC	Less than the specified value				

Surface Mount Type
Aluminum Electrolytic Capacitors

- CE-LD
- CE-FSS
- CE-FS(High Voltage)
- CE-FS
- CE-AX
- CE-ZX
- CE-ZC
- CE-LX
- CE-GA
- CE-LS
- CE-LH
- CE-LH(High Voltage)
- CE-LL
- CE-LF
- CE-PC
- CE-PH
- CE-PS
- CE-PF
- CE-TH
- CE-JX
- CE-FN

Marking, Dimensions

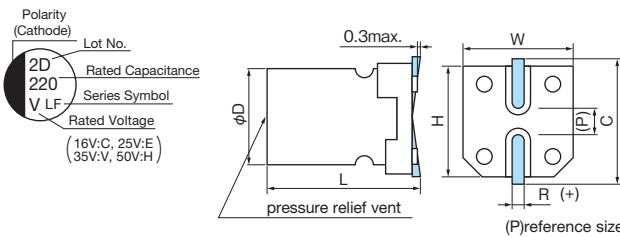

(Unit : mm)

D ^{±0.5}	L ^{±0.3}	W ^{±0.2}	H ^{±0.2}	C ^{±0.2}	R	P
8	10.5	8.3	8.3	9.0	0.7 to 1.0	3.2
10	10.5	10.3	10.3	11.0	1.0 to 1.4	4.6

Size, Impedance, Rated Ripple Current

μF \ V	16			25			35			50		
100										8×10.5	0.53	350
220							8×10.5	0.22	600	10×10.5	0.35	670
330				8×10.5	0.22	600	10×10.5	0.16	850			
470	8×10.5	0.22	600	10×10.5	0.16	850						

Please refer to page 14 for ripple current frequency coefficients.

Impedance(Ω)
max. at 100kHz, 20°C

Rated ripple current
mA Arms(100kHz, 105°C)

Case size: φD×L(mm)

Part number

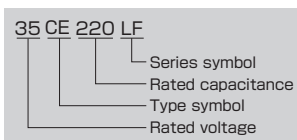

CE-PC Series

125°C



- 125°C 1,000 to 2,000hours
- Solvent proof (within 2 minutes)
- AEC-Q200

Specifications

Items	Condition	Specifications									
Rated voltage (V)	—	6.3	10	16	25	35	50	63	100		
Surge voltage (V)	Room temperature	8.0	13	20	32	44	63	79	125		
Category temperature range (°C)	—	-55 to +125									
Capacitance tolerance (%)	120Hz/20°C	M : ±20									
Dissipation Factor(tan δ)	tanδ(max.)120Hz/20°C	0.30	0.24	0.20	0.16	0.14	0.14	0.12	0.10		
Leakage current(LC)	μA/after 2minutes (max.), 20°C	Exceeding 1,000μF, +0.02 every 1,000μF									
Impedance ratio at low temperature	Based on the value at 120Hz, +20°C	-25°C Z/Z _{20°C}	4	3	2	2	2	2	2	2	
		-40°C Z/Z _{20°C}	8	6	4	3	3	3	3	3	
Endurance	125°C rated voltage applied (With the rated ripple current)	Test	6.3 to 50V 2,000hours. (φD=6.3 : 1,000hours.), 63 to 100V 1,500hours								
		ΔC/C	Within ±30% of the initial value								
		tanδ	Less than 300% of the specified value								
		LC	Less than the specified value								

Marking, Dimensions

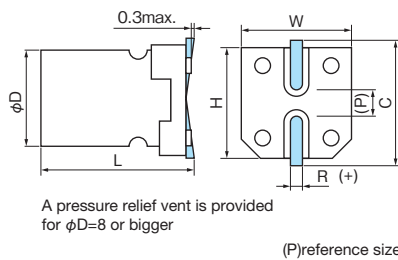
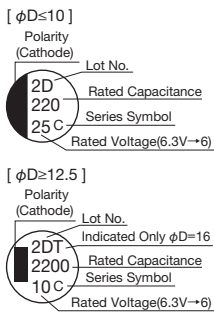

(Unit : mm)

D ^{±0.5}	L ^{±0.3}	W ^{±0.2}	H ^{±0.2}	C ^{±0.2}	R	P
6.3	6.0	6.6	6.6	7.3	0.5 to 0.8	2.2
6.3	7.7	6.6	6.6	7.3	0.5 to 0.8	2.2
8	10.2	8.3	8.3	9.0	0.7 to 1.0	3.2
10	10.2	10.3	10.3	11.0	1.0 to 1.4	4.6
12.5	13.5 ^{±0.5}	12.8	12.8	13.5	1.0 to 1.4	4.6
16	16.5 ^{±0.5}	16.3	16.3	17.3	1.7 to 2.1	7.0

■ Size, ESR, Rated Ripple Current

μF \ V	6.3			10			16			25		
33										6.3x6.0	1.6	70
47				6.3x6.0	1.6	70	6.3x6.0	1.6	70	6.3x7.7	0.90	110
100							6.3x7.7 ★	0.90	110	6.3x7.7 ★	0.90	110
	6.3x6.0	1.6	70	6.3x7.7	0.90	110	8x10.2	0.40	160	8x10.2	0.40	160
220				6.3x7.7 ★	0.90	110				8x10.2 ★	0.40	160
	6.3x7.7	0.90	110	8x10.2	0.40	160	8x10.2	0.40	160	10x10.2	0.30	296
330				8x10.2	0.40	160				10x10.2 ★	0.30	296
	8x10.2	0.40	160	8x10.2	0.40	160	10x10.2	0.30	296	12.5x13.5	0.12	550
470	8x10.2	0.40	160	10x10.2	0.30	296	12.5x13.5	0.12	550	12.5x13.5	0.12	550
680	10x10.2	0.30	296	12.5x13.5	0.12	550	12.5x13.5	0.12	550	12.5x13.5	0.12	550
1000	12.5x13.5	0.12	550	12.5x13.5	0.12	550	12.5x13.5	0.12	550	16x16.5	0.080	900
1500	12.5x13.5	0.12	550	12.5x13.5	0.12	550	16x16.5	0.080	900	16x16.5	0.080	900
2200	12.5x13.5	0.12	550	16x16.5	0.080	900	16x16.5	0.080	900			
3300	16x16.5	0.080	900	16x16.5	0.080	900						
4700	16x16.5	0.080	900									

μF \ V	35			50			63			100		
2.2				6.3x6.0	3.5	45						
3.3				6.3x6.0	3.5	45						
4.7	6.3x6.0	2.0	60	6.3x6.0	3.5	45						
10	6.3x6.0	1.6	70	6.3x6.0	2.8	50				8x10.2	1.0	70
22	6.3x6.0	1.6	70	6.3x7.7	2.0	80	8x10.2	1.0	100	8x10.2	1.0	70
33				6.3x7.7 ★	2.0	80						
	6.3x7.7	0.90	110	8x10.2	0.70	140	8x10.2	1.0	100	10x10.2	0.80	115
47	6.3x7.7 ★	0.90	110	8x10.2 ★	0.70	140	8x10.2 ★	1.0	100			
	8x10.2	0.40	160	10x10.2	0.50	247	10x10.2	0.50	150	12.5x13.5	0.33	350
100	8x10.2 ★	0.40	160	10x10.2 ★	0.50	247	10x10.2 ★	0.50	150			
	10x10.2	0.30	296	12.5x13.5	0.23	490	12.5x13.5	0.25	350	16x16.5	0.24	500
220	10x10.2 ★	0.30	296				12.5x13.5 ★	0.25	350			
	12.5x13.5	0.12	550	12.5x13.5	0.23	490	16x16.5	0.18	500			
330				12.5x13.5 ★	0.23	490						
	12.5x13.5	0.12	550	16x16.5	0.15	800	16x16.5	0.18	500			
470	12.5x13.5 ★	0.12	550									
	16x16.5	0.080	900	16x16.5	0.15	800	16x16.5	0.18	500			
680	16x16.5	0.080	900	16x16.5	0.15	800						
1000	16x16.5	0.080	900									

Please refer to page 14 for ripple current frequency coefficients.

Case size: $\phi D \times L$ (mm)
16x16.5: CE-PCT

Rated ripple current
mArms(100kHz, 125°C)

ESR(Ω)
max. at 100kHz, 20°C

★ PCS

■ Part number

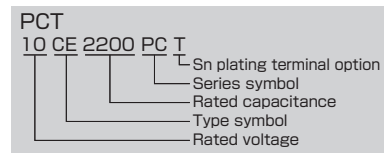
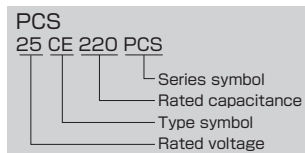
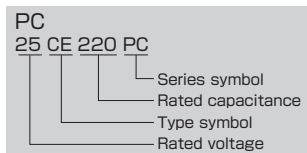

CE-PH Series

125°C Low ESR

High Ripple Current,
High Capacitance



UP GRADE

- 125°C 2,000 to 5,000hours
- Solvent proof (within 2 minutes)
- AEC-Q200

Specifications

Items	Condition	Specifications				
Rated voltage (V)	—	16	25	35	50	63
Surge voltage (V)	Room temperature	20	32	44	63	79
Category temperature range (°C)	—	-40 to +125				
Capacitance tolerance (%)	120Hz/20°C	M : ±20				
Dissipation Factor (tan δ)	tanδ (max.) 120Hz/20°C	0.20	0.16	0.14	0.14	0.14
		Exceeding 1,000μF, +0.02 every 1,000μF				
Leakage current (LC)	μA/after 2minutes (max.), 20°C	0.01CV				
Impedance ratio at low temperature	Based on the value at 120Hz, +20°C	-25°C Z/Z _{20°C}	2	2	2	2
		-40°C Z/Z _{20°C}	4	3	3	3
Endurance	125°C rated voltage applied (With the rated ripple current)	Test	φ6.3 to φ10 : 2,000hours, φ12.5 : 3,000hours, φ16, φ18 : 5,000hours			
		ΔC/C	Within ±30% of the initial value			
		tanδ	Less than 300% of the specified value			
		LC	Less than the specified value			

Marking, Dimensions

(Unit : mm)

[φD≤10]

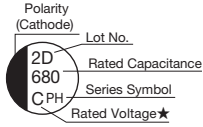

[φD≥12.5]

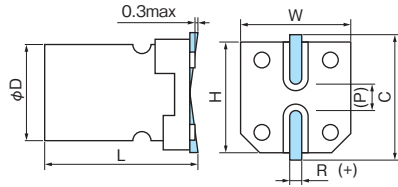
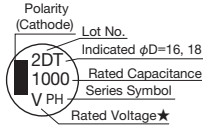

A pressure relief vent is provided for φD=8 or bigger

(P)reference size

D ^{±0.5}	L ^{±0.3}	W ^{±0.2}	H ^{±0.2}	C ^{±0.2}	R	P
6.3	6.0	6.6	6.6	7.3	0.5 to 0.8	2.2
6.3	7.7	6.6	6.6	7.3	0.5 to 0.8	2.2
8	10.5	8.3	8.3	9.0	0.7 to 1.0	3.2
10	10.5	10.3	10.3	11.0	1.0 to 1.4	4.6
12.5	13.5 ^{±0.5}	12.8	12.8	13.5	1.0 to 1.4	4.6
16	16.5 ^{±0.5}	16.3	16.3	17.3	1.7 to 2.1	7.0
16	21.5 ^{±1.0}	16.3	16.3	17.3	1.7 to 2.1	7.0
18	16.5 ^{±1.0}	19.0	19.0	20.0	1.7 to 2.1	7.0
18	21.5 ^{±1.0}	19.0	19.0	20.0	1.7 to 2.1	7.0

★(16V:C, 25V:E, 35V:V, 50V:H, 63V:J)

Aluminum Electrolytic Capacitors Surface Mount Type

- CE-LD
- CE-FSS
- CE-FS(High Voltage)
- CE-FS
- CE-AX
- CE-ZX
- CE-ZC
- CE-LX
- CE-GA
- CE-LS
- CE-LH
- CE-LH(High Voltage)
- CE-LL
- CE-LF
- CE-PC
- CE-PH
- CE-PS
- CE-PF
- CE-TH
- CE-JX
- CE-FN

■ Size, ESR, Rated Ripple Current

μF \ V	16				25				35			
22									6.3x6.0	1.6	—	110
33									6.3x6.0 ★	1.6	—	110
					6.3x6.0	1.6	—	110	6.3x7.7	0.45	5.0	200
47	6.3x6.0	1.6	—	110					6.3x7.7	0.45	5.0	200
100	6.3x7.7	0.45	5.0	200	6.3x7.7	0.45	5.0	200	8x10.5	0.18	3.0	300
160									8x10.5	0.18	3.0	300
220					8x10.5	0.18	3.0	300	10x10.5	0.11	2.0	500
270					8x10.5	0.18	3.0	300				
300									10x10.5	0.11	2.0	500
330	8x10.5	0.18	3.0	300	10x10.5	0.11	2.0	500	12.5x13.5	0.08	1.0	1200
390	8x10.5	0.18	3.0	300								
470	10x10.5	0.11	2.0	500	10x10.5	0.11	2.0	500	12.5x13.5	0.08	1.0	1200
620									12.5x13.5	0.08	1.0	1200
680	10x10.5	0.11	2.0	500	12.5x13.5	0.08	1.0	1200	16x16.5	0.05	0.5	1800
910					12.5x13.5	0.08	1.0	1200				
1000	12.5x13.5	0.08	1.0	1200	16x16.5	0.05	0.5	1800	16x16.5	0.05	0.5	1800
1500	12.5x13.5	0.08	1.0	1200	16x16.5	0.05	0.5	1800	18x16.5	0.045	0.45	2000
1600									16x21.5	0.045	0.45	2000
2200	16x16.5	0.05	0.5	1800	18x16.5	0.045	0.45	2000	18x21.5	0.04	0.4	2200
2700					16x21.5	0.045	0.45	2000				
3300	18x16.5	0.045	0.45	2000	18x21.5	0.04	0.4	2200				
3900	18x21.5	0.04	0.4	2200								

μF \ V	50				63			
10	6.3x6.0	2.0	—	70	6.3x7.7	2.0	20	60
22					8x10.5	0.70	7.0	140
33					8x10.5	0.70	7.0	140
47	8x10.5	0.45	5.0	250	8x10.5	0.70	7.0	140
100	10x10.5	0.30	3.0	350	10x10.5 ★	0.30	3.0	260
					12.5x13.5	0.18	2.0	700
150					12.5x13.5	0.18	2.0	700
220	12.5x13.5	0.15	1.5	700	12.5x13.5	0.18	2.0	700
330					16x16.5	0.13	1.3	1000
470	16x16.5	0.09	0.9	1000	16x16.5	0.13	1.3	1000
560					16x21.5	0.085	0.85	1200
680	18x16.5	0.07	0.7	1200				
820	16x21.5	0.05	0.5	1200				
1000	18x21.5	0.05	0.5	1650				

Please refer to page 14 for ripple current frequency coefficients.

★ PHS

Case size: $\phi D \times L$ (mm)
 $\phi 16, \phi 18$: CE-PHT

ESR(Ω)
max. at 100kHz, 20°C

ESR(Ω)
max. at 100kHz, -40°C

Rated ripple current
mA_{rms}(100kHz, 125°C)

■ Part number

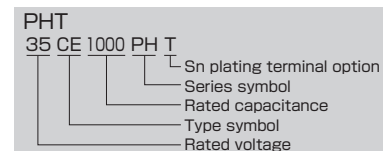
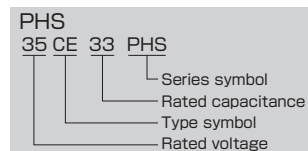
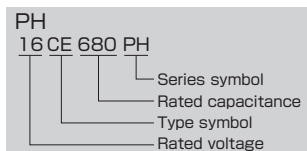

CE-PS Series

125°C

High Capacitance



- 125°C 1,000 to 4,000hours
- Solvent proof (within 2 minutes)
- AEC-Q200

Specifications

Items	Condition	Specifications			
Rated voltage (V)	—	16	25	35	
Surge voltage (V)	Room temperature	20	32	44	
Category temperature range (°C)	—	-40 to +125			
Capacitance tolerance (%)	120Hz/20°C	M : ±20			
Dissipation Factor (tan δ)	tanδ (max.) 120Hz/20°C	0.20	0.16	0.14	
Leakage current (LC)	μA/after 2minutes (max.), 20°C	0.01CV			
Impedance ratio at low temperature	Based on the value at 120Hz, +20°C	-25°C Z/Z _{20°C}	2	2	2
		-40°C Z/Z _{20°C}	4	3	3
Endurance	125°C rated voltage applied (With the rated ripple current)	Test	φ6.3×6.0 : 1,000hours, φ6.3×7.7 to φ10×10.5 : 2,000hours, φ10×13.5 : 4,000hours		
		ΔC/C	Within ±30% of the initial value		
		tanδ	Less than 300% of the specified value		
		LC	Less than the specified value		

Marking, Dimensions

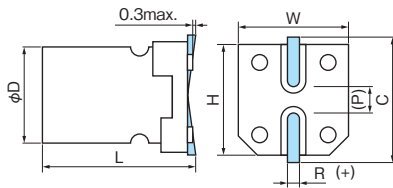
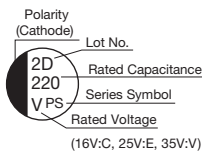

(Unit : mm)

D ^{±0.5}	L ^{±0.3}	W ^{±0.2}	H ^{±0.2}	C ^{±0.2}	R	P
6.3	6.0	6.6	6.6	7.3	0.5 to 0.8	2.2
6.3	7.7	6.6	6.6	7.3	0.5 to 0.8	2.2
8	10.5	8.3	8.3	9.0	0.7 to 1.0	3.2
10	10.5	10.3	10.3	11.0	1.0 to 1.4	4.6
10	13.5 ^{±0.5}	10.3	10.3	11.0	1.0 to 1.4	4.6

(P)Preference size

Size, ESR, Rated Ripple Current

μF \ V	16			25			35		
	47						6.3×6.0	1.20	110
100	6.3×6.0	1.20	110			6.3×7.7	0.60	220	
150				6.3×7.7	0.60	220			
220						8×10.5	0.30	300	
330				8×10.5	0.30	300	10×10.5	0.20	500
390						10×13.5	★ 0.15	710	
470				10×10.5	0.20	500	10×13.5	★ 0.15	710
560				10×13.5	★ 0.15	710	10×13.5	★ 0.15	710
680				10×13.5	★ 0.15	710			

Please refer to page 14 for ripple current frequency coefficients.

Case size: φD×L(mm)

ESR(Ω)
max. at 100kHz, 20°C

Rated ripple current
mArms(100kHz, 125°C)

★ PSC

Part number

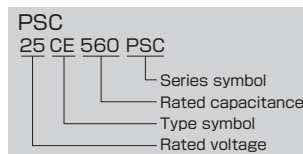
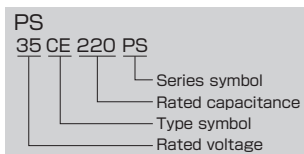

CE-PF Series

125°C Long Life

High Ripple Current



- 125°C 4,000hours
- Solvent proof (within 2 minutes)
- AEC-Q200

Specifications

Items	Condition	Specifications	
Rated voltage (V)	—	25	35
Surge voltage (V)	Room temperature	32	44
Category temperature range (°C)	—	-40 to +125	
Capacitance tolerance (%)	120Hz/20°C	M : ±20	
Dissipation Factor (tan δ)	tanδ (max.) 120Hz/20°C	0.16	0.14
Leakage current (LC)	µA/after 2minutes (max.), 20°C	0.01CV	
Impedance ratio at low temperature	Based on the value at 120Hz, +20°C	-25°C Z/Z _{20°C}	2
		-40°C Z/Z _{20°C}	3
Endurance	125°C, 4,000hours rated voltage applied (With the rated ripple current)	ΔC/C	Within ±30% of the initial value
		tanδ	Less than 300% of the specified value
		LC	Less than the specified value

Marking, Dimensions

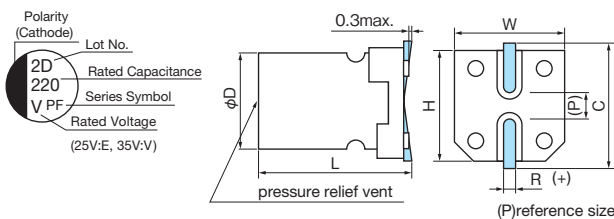

(Unit : mm)

D ^{±0.5}	L ^{±0.3}	W ^{±0.2}	H ^{±0.2}	C ^{±0.2}	R	P
8	10.5	8.3	8.3	9.0	0.7 to 1.0	3.2
10	10.5	10.3	10.3	11.0	1.0 to 1.4	4.6

Size, ESR, Rated Ripple Current

µF	V	25			35		
		Case size: φDxL (mm)	ESR (Ω) max. at 100kHz, 20°C	Rated ripple current mArms (100kHz, 125°C)	Case size: φDxL (mm)	ESR (Ω) max. at 100kHz, 20°C	Rated ripple current mArms (100kHz, 125°C)
100							
150		8×10.5	0.30	300	8×10.5	0.30	300
220					10×10.5	0.20	500
330		10×10.5	0.20	500			

Please refer to page 14 for ripple current frequency coefficients.

Case size: φDxL (mm)

ESR (Ω) max. at 100kHz, 20°C

Rated ripple current mArms (100kHz, 125°C)

Part number

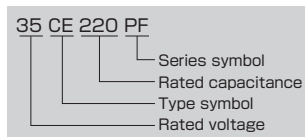

CE-TH Series

135°C



- 135°C 1,000 to 2,000hours
- Solvent proof (within 2 minutes)
- AEC-Q200

Specifications

Items	Condition	Specifications				
Rated voltage (V)	—	16	25	35	50	
Surge voltage (V)	Room temperature	20	32	44	63	
Category temperature range (°C)	—	-40 to +135				
Capacitance tolerance (%)	120Hz/20°C	M : ±20				
Dissipation Factor (tan δ)	tanδ (max.) 120Hz/20°C	0.23	0.18	0.16	0.16	
Leakage current (LC)	μA/after 2minutes (max.), 20°C	0.01CV				
Impedance ratio at low temperature	Based on the value at 120Hz, +20°C	-25°C Z/Z _{20°C}	2	2	2	2
		-40°C Z/Z _{20°C}	4	3	3	3
Endurance	135°C rated voltage applied (With the rated ripple current)	Test	2,000hours(φ6.3×7.7 1,000hours)			
		ΔC/C	Within ±30% of the initial value			
		tanδ	Less than 300% of the specified value			
		LC	Less than the specified value			

Marking, Dimensions

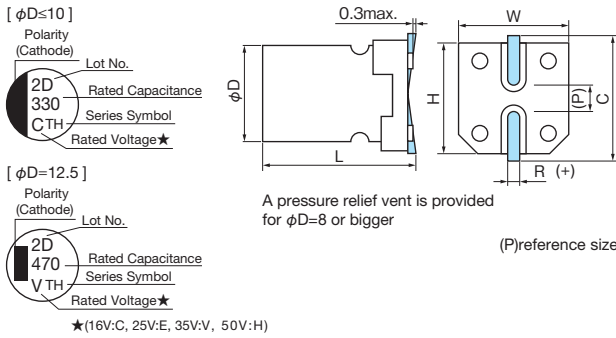

(Unit : mm)

D ^{±0.5}	L ^{±0.3}	W ^{±0.2}	H ^{±0.2}	C ^{±0.2}	R	P
6.3	7.7	6.6	6.6	7.3	0.5 to 0.8	2.2
8	10.5	8.3	8.3	9.0	0.7 to 1.0	3.2
10	10.5	10.3	10.3	11.0	1.0 to 1.4	4.6
12.5	13.5 ^{±0.5}	12.8	12.8	13.5	1.0 to 1.4	4.6

Size, ESR, Rated Ripple Current

μF \ V	16			25			35			50		
22										6.3×7.7	1.20	110
33							6.3×7.7	0.80	150			
47							6.3×7.7	0.80	150	8×10.5	0.60	160
100	6.3×7.7	0.80	150	6.3×7.7	0.80	150	8×10.5	0.30	240	10×10.5	0.35	260
220				8×10.5	0.30	240	10×10.5	0.20	400	12.5×13.5	0.15	600
330	8×10.5	0.30	240	10×10.5	0.20	400	12.5×13.5	0.10	750			
470	10×10.5	0.20	400				12.5×13.5	0.10	750			
680				12.5×13.5	0.10	750						
1000	12.5×13.5	0.10	750									

Please refer to page 14 for ripple current frequency coefficients.

ESR(Ω) max. at 100kHz, 20°C
 Case size:φD×L(mm)
 Rated ripple current mArms(100kHz, 135°C)

Part number

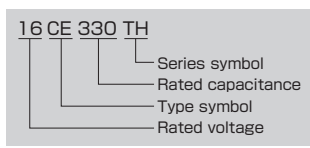

CE-JX Series

150°C



- 150°C 1,000hours
- Solvent proof (within 2 minutes)
- AEC-Q200

Specifications

Items	Condition	Specifications	
Rated voltage (V)	—	25	35
Surge voltage (V)	Room temperature	32	44
Category temperature range (°C)	—	-40 to +150	
Capacitance tolerance (%)	120Hz/20°C	M : ±20	
Dissipation Factor(tan δ)	tanδ (max.) 120Hz/20°C	0.16	0.14
Leakage current (LC)	μA/after 2minutes (max.), 20°C	0.01CV	
Impedance ratio at low temperature	Based on the value at 120Hz, +20°C	-25°C Z/Z _{20°C}	2
		-40°C Z/Z _{20°C}	3
Endurance	150°C, 1,000hours rated voltage applied (With the rated ripple current)	ΔC/C	Within ±30% of the initial value
		tanδ	Less than 300% of the specified value
		LC	Less than the specified value

 Surface Mount Type
 Aluminum Electrolytic Capacitors

 CE-LD
 CE-FSS
 CE-FS(High Voltage)
 CE-FS
 CE-AX
 CE-ZX
 CE-ZC
 CE-LX
 CE-GA
 CE-LS
 CE-LH
 CE-LH(High Voltage)
 CE-LL
 CE-LF
 CE-PC
 CE-PH
 CE-PS
 CE-PF
 CE-TH
 CE-JX
 CE-FN

Marking, Dimensions

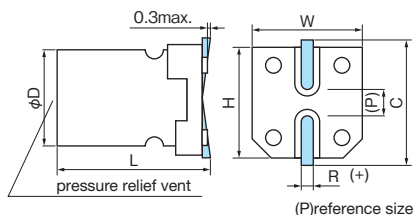
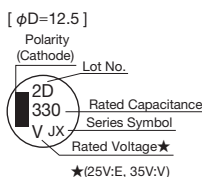
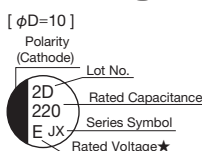

(Unit : mm)

D ^{±0.5}	L	W ^{±0.2}	H ^{±0.2}	C ^{±0.2}	R	P
10	10.5 ^{±0.3}	10.3	10.3	11.0	1.0 to 1.4	4.6
12.5	13.5 ^{±0.5}	12.8	12.8	13.5	1.0 to 1.4	4.6

Size, ESR, Rated Ripple Current

μF	V	25			35		
100					10×10.5	0.20	120
150					10×10.5	0.20	120
220		10×10.5	0.20	150	12.5×13.5	0.15	550
330		12.5×13.5	0.15	650	12.5×13.5	0.15	650
470		12.5×13.5	0.15	700			

Please refer to page 14 for ripple current frequency coefficients.

Case size: φDxL(mm)

 Rated ripple current
 mA rms (100kHz, 150°C)
 ESR(Ω)
 max. at 100kHz, 20°C

Part number

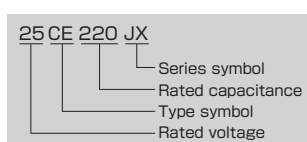

CE-FN Series

105°C Bi-polar

5.4mm Height



- 105°C 1,000hours
- Solvent proof (within 2 minutes)
- AEC-Q200

Specifications

Items	Condition	Specifications								
Rated voltage (V)	—	6.3	10	16	25	35	50	63		
Surge voltage (V)	Room temperature	8.0	13	20	32	44	63	79		
Category temperature range (°C)	—	-55 to +105								
Capacitance tolerance (%)	120Hz/20°C	M : ±20								
Dissipation Factor (tan δ)	tanδ (max.) 120Hz/20°C	0.24	0.22	0.20	0.20	0.20	0.18	0.16		
Leakage current (LC)	μA/after 1minute (max.), 20°C	0.03CV + 6								
Impedance ratio at low temperature	Based on the value at 120Hz, +20°C	-40°C Z/Z _{20°C}	3	3	2	2	2	2	2	
		-55°C Z/Z _{20°C}	8	6	4	4	3	3	3	
Endurance	500hours×2 (alternately) 105°C, rated voltage applied (With the rated ripple current)	ΔC/C	Within ±25% of the initial value							
		tanδ	Less than 200% of the specified value							
		LC	Less than the specified value							

Marking, Dimensions

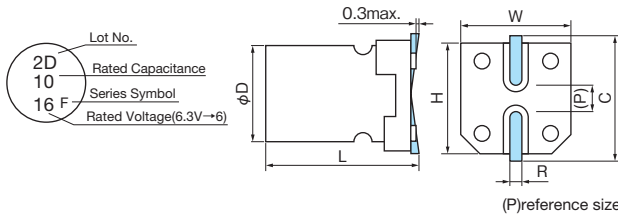

(Unit : mm)

D ^{±0.5}	L ^{+0.1 -0.2}	W ^{±0.2}	H ^{±0.2}	C ^{±0.2}	R	P
4	5.4	4.3	4.3	5.0	0.5 to 0.8	1.0
5	5.4	5.3	5.3	6.0	0.5 to 0.8	1.4
6.3	5.4	6.6	6.6	7.3	0.5 to 0.8	2.2

Size, Rated Ripple Current

μF \ V	6.3	10	16	25	35	50	63
1.0						4	7.0
2.2					4	5.9	10
3.3				4	7.0	5	13
4.7			4	8.0	5	14	16
10		4	12	5	17	6.3	21
22	5	22	6.3	25	6.3	27	
33	6.3	27	6.3	30	6.3	40	
47	6.3	33					

Please refer to page 14 for ripple current frequency coefficients.

Case size: φD (mm)

Rated ripple current mArms (120Hz, 105°C)

Part number

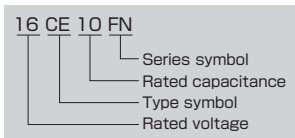

Aluminum Electrolytic Capacitors
 Surface Mount Type
 CE-LD
 CE-FSS
 CE-FS(High Voltage)
 CE-FS
 CE-AX
 CE-ZX
 CE-ZC
 CE-LX
 CE-GA
 CE-LS
 CE-LH
 CE-LH(High Voltage)
 CE-LL
 CE-LF
 CE-PC
 CE-PH
 CE-PS
 CE-PF
 CE-TH
 CE-JX
 CE-FN

MEMO

ME-SZ Series

7mm Height, Wide Temperature



- 105°C 1,000hours, Solvent proof (within 3 minutes)

Specifications

Items	Condition	Specifications					
Rated voltage (V)	—	6.3	10	16	25	35	50
Surge voltage (V)	Room temperature	8.0	13	20	32	44	63
Category temperature range (°C)	—	-55 to +105					
Capacitance tolerance (%)	120Hz/20°C	M : ±20					
Dissipation Factor (tan δ)	tanδ (max.) 120Hz/20°C	0.24	0.20	0.16	0.14	0.12	0.10
Leakage current (LC)	μA/after 2minutes (max.), 20°C	The greater value of either 0.01CV or 3					
Impedance ratio at low temperature	Based on the value at 120Hz, +20°C	-40°C Z/Z _{20°C}	3	2	2	2	2
		-55°C Z/Z _{20°C}	5	4	4	3	3
Endurance	105°C, 1,000hours rated voltage applied (With the rated ripple current)	ΔC/C	Within ±25% of the initial value				
		tanδ	Less than 200% of the specified value				
		LC	Less than the specified value				

Dimensions

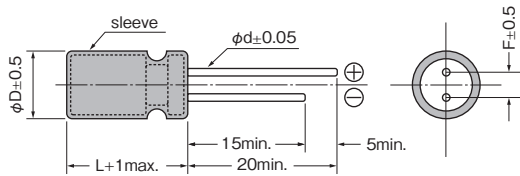

(Unit : mm)

φD	4	5	6.3
F	1.5	2.0	2.5
φd	0.45	0.45	0.45

Size, Impedance, Rated Ripple Current

μF \ V	6.3			10			16			25			35			50		
1.0																4x7	10	30
2.2																4x7	7.8	35
3.3																4x7	6.2	40
4.7										4x7	4.2	50	4x7	6.0	40	5x7	3.1	70
10							4x7	4.2	50	5x7	2.0	85	5x7	3.1	70	6.3x7	1.6	100
22	4x7	4.2	50	5x7	2.0	85	5x7	2.0	85	6.3x7	1.2	120	6.3x7	1.6	100	6.3x7	1.6	100
33	5x7	2.0	85	5x7	2.0	85	6.3x7	1.2	120	6.3x7	1.2	120	6.3x7	1.6	100	6.3x7	1.6	100
47	5x7	2.0	85	6.3x7	1.2	120	6.3x7	1.2	120	6.3x7	1.2	120	6.3x7	1.6	100	6.3x7	1.6	100
100	6.3x7	1.2	120	6.3x7	1.2	120	6.3x7	1.2	120	6.3x7	1.2	120	6.3x7	1.6	100			
220	6.3x7	1.2	120	6.3x7	1.2	120	6.3x7	1.2	120									
330	6.3x7	1.2	120															

Please refer to page 14 for ripple current frequency coefficients.

Case size: φDxL (mm) Impedance(Ω) max. at 100kHz, 20°C Rated ripple current mA rms (100kHz, 105°C)

Part number

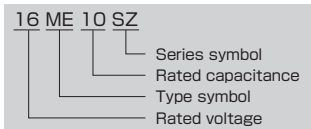

ME-SAX Series

Low Impedance

7mm Height



- 105°C 1,000hours, Solvent proof (within 3 minutes)

Specifications

Items	Condition	Specifications					
Rated voltage (V)	—	6.3	10	16	25	35	
Surge voltage (V)	Room temperature	8.0	13	20	32	44	
Category temperature range (°C)	—	-55 to +105					
Capacitance tolerance (%)	120Hz/20°C	M : ±20					
Dissipation Factor (tan δ)	tanδ (max.) 120Hz/20°C	0.24	0.20	0.16	0.14	0.12	
Leakage current (LC)	μA/after 2minutes (max.), 20°C	The greater value of either 0.01CV or 3					
Impedance ratio at low temperature	Based on the value at 120Hz, +20°C	-40°C Z/Z _{20°C}	3	2	2	2	2
		-55°C Z/Z _{20°C}	5	4	4	3	3
Endurance	105°C, 1,000hours rated voltage applied (With the rated ripple current)	ΔC/C	Within ±25% of the initial value				
		tanδ	Less than 200% of the specified value				
		LC	Less than the specified value				

Dimensions

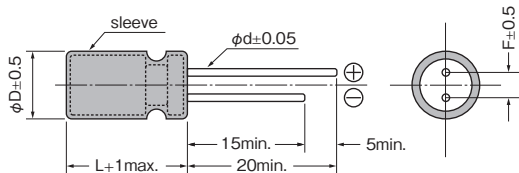

(Unit : mm)

φD	4	5	6.3
F	1.5	2.0	2.5
φd	0.45	0.45	0.45

Size, Impedance, Rated Ripple Current

μF \ V	6.3			10			16			25			35		
4.7												4x7	1.15	90	
10									4x7	1.15	90	5x7	0.49	160	
15							4x7	1.15	90	5x7	0.49	160	6.3x7	0.29	280
22				4x7	1.15	90	5x7	0.49	160	5x7	0.49	160	6.3x7	0.29	280
33				5x7	0.49	160	5x7	0.49	160	6.3x7	0.24	280	6.3x7	0.29	280
47	5x7	0.49	160	5x7	0.49	160	6.3x7	0.24	280	6.3x7	0.24	280	6.3x7	0.29	280
68										6.3x7	0.24	280			
100				6.3x7	0.24	280	6.3x7	0.24	280	6.3x7	0.29	280			
150				6.3x7	0.24	280	6.3x7	0.29	280						
220	6.3x7	0.24	280	6.3x7	0.29	280	6.3x7	0.29	280						
330	6.3x7	0.29	280												

Please refer to page 14 for ripple current frequency coefficients.

Case size: φDxL (mm)

Impedance (Ω) max. at 100kHz, 20°C

Rated ripple current mArms (100kHz, 105°C)

Part number

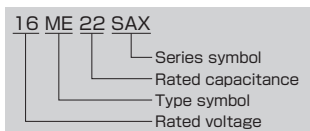

ME-SWG Series

Low ESR, Small

7mm Height



- 105°C 1,000 to 2,000hours
- Non solvent proof

Specifications

Items	Condition	Specifications					
Rated voltage (V)	—	6.3	10	16	25	35	
Surge voltage (V)	Room temperature	8.0	13	20	32	44	
Category temperature range (°C)	—	-40 to +105					
Capacitance tolerance (%)	120Hz/20°C	M : ±20					
Dissipation Factor (tan δ)	tanδ (max.) 120Hz/20°C	0.24	0.20	0.16	0.14	0.12	
Leakage current (LC)	µA/after 2minutes (max.), 20°C	0.03CV					
Impedance ratio at low temperature	Based on the value at 120Hz, +20°C	-25°C Z/Z _{20°C}	2	2	2	2	2
		-40°C Z/Z _{20°C}	3	3	3	3	3
Endurance	105°C rated voltage applied (With the rated ripple current)	Test	φ5 : 1,000hours, φ6.3 : 2,000hours, (6ME330SWG, 10ME220SWG : 1,000hours)				
		ΔC/C	Within ±25% of the initial value(6.3V, 10V : ±30%)				
		tanδ	Less than 200% of the specified value				
		LC	Less than the specified value				

Dimensions

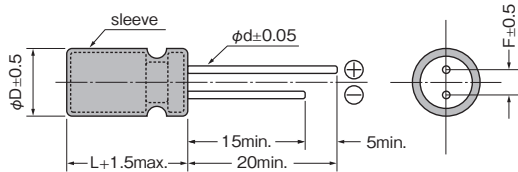

(Unit : mm)

φD	5	6.3
F	2.0	2.5
φd	0.45	0.45

Size, ESR, Rated Ripple Current

µF	6.3		10		16		25		35			
	V											
22							5×7	0.17	390	5×7	0.17	390
39							5×7	0.17	390			
47										6.3×7	0.082	760
56				5×7	0.17	390						
100	5×7	0.17	390	6.3×7	0.082	760	6.3×7	0.082	760	6.3×7	0.082	760
150	6.3×7	0.082	760	6.3×7	0.082	760	6.3×7	0.082	760			
220	6.3×7	0.082	760	6.3×7	0.082	760						
330	6.3×7	0.082	760									

Please refer to page 14 for ripple current frequency coefficients.

ESR(Ω)
max. at 100kHz, 20°C

Rated ripple current
mA_{rms}(100kHz, 105°C)

Case size:φDxL(mm)

Part number

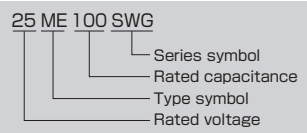

ME-LS Series

105°C

Long Life



- 105°C 3,000hours
- Solvent proof ($\phi 4$ to 6.3 : within 3 minutes, $\phi 8$: within 5 minutes)

Specifications

Items	Condition	Specifications						
Rated voltage (V)	—	6.3	10	16	25	35	50	
Surge voltage (V)	Room temperature	8.0	13	20	32	44	63	
Category temperature range (°C)	—	-40 to +105						
Capacitance tolerance (%)	120Hz/20°C	M : ± 20						
Dissipation Factor (tan δ)	tan δ (max.) 120Hz/20°C	0.30	0.28	0.24	0.18	0.16	0.14	
Leakage current (LC)	μA /after 2minutes (max.), 20°C	The greater value of either 0.01CV or 3						
Impedance ratio at low temperature	Based on the value at 120Hz, +20°C	-25°C Z/Z _{20°C}	5	4	3	2	2	2
		-40°C Z/Z _{20°C}	10	8	6	4	3	3
Endurance	105°C, 3,000hours rated voltage applied (With the rated ripple current)	$\Delta C/C$	Within $\pm 30\%$ of the initial value					
		tan δ	Less than 300% of the specified value					
		LC	Less than the specified value					

Dimensions

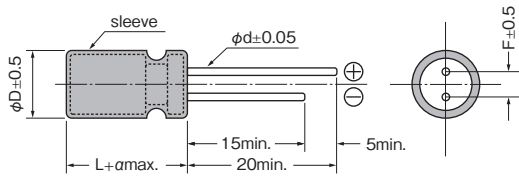

$\alpha : L \leq 7.5 \quad \alpha = 1.0, L = 11.5 \quad \alpha = 1.5$

A pressure relief vent is provided for $\phi 8 \times 11.5$

(Unit : mm)

ϕD	4	5	6.3	8
F	1.5	2.0	2.5	3.5
ϕd	0.45	0.45	0.45	0.60

Size, Impedance, Rated Ripple Current

μF	V	6.3	10	16	25	35	50
1.0							4x7 17.0 23
2.2							4x7 13.0 26
3.3							4x7 11.0 29
4.7						4x7 6.6 37	5x7 9.0 37
10				4x7 4.2 46	4x7 4.2 46	5x7 2.3 74	6.3x7 2.5 84
22	4x7 4.2 46			5x7 2.3 74	5x7 2.3 74	6.3x7 1.2 120	6.3x7.5 1.6 112
33		5x7 2.3 74			6.3x7 1.2 120	6.3x7.5 0.75 163	
47	5x7 2.3 74			6.3x7 1.2 120	6.3x7.5 0.75 163	6.3x7.5 0.75 163	
100	6.3x7 1.2 120			6.3x7.5 0.75 163			
150		6.3x7.5 0.75 163					
220	6.3x7.5 0.75 163				8x11.5 0.40 298	8x11.5 0.40 298	
330					8x11.5 0.40 298		
470				8x11.5 0.40 298			
1000	8x11.5 0.40 298						

Please refer to page 14 for ripple current frequency coefficients.

Case size: $\phi D \times L$ (mm)

Rated ripple current
mA rms (100kHz, 105°C)

Impedance (Ω)
max. at 100kHz, 20°C

Part number

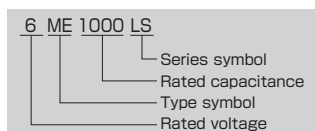

Radial Lead Type
Aluminum Electrolytic Capacitors

- ME-SZ
- ME-SAX
- ME-SWG
- ME-LS
- ME-CZ
- ME-CA
- ME-CX
- ME-AX
- ME-WX
- ME-WA
- ME-WL
- ME-WG
- ME-FX
- ME-FC-FD
- ME-FH
- ME-SWN
- ME-HWN

ME-CZ Series

Small Standard

Wide Temperature



- 105°C 1,000 to 3,000hours
- Solvent proof (within 5 minutes)

Specifications

Items	Condition	Specifications									
Rated voltage (V)	—	6.3	10	16	25	35	50	63	100		
Surge voltage (V)	Room temperature	8.0	13	20	32	44	63	79	125		
Category temperature range (°C)	—	-55 to +105									
Capacitance tolerance (%)	120Hz/20°C	M : ±20									
Dissipation Factor (tan δ)	tanδ(max.) 120Hz/20°C	0.28	0.24	0.20	0.16	0.14	0.12	0.10	0.10		
		Exceeding 1,000µF, +0.02 every 1,000µF									
Leakage current(LC)	µA/after 2minutes (max.), 20°C	The greater value of either 0.01CV or 3									
Impedance ratio at low temperature	Based on the value at 120Hz, +20°C	-40°C Z/Z _{20°C}	4	4	3	3	2	2	2	2	
		-55°C Z/Z _{20°C}	10	8	6	5	4	3	3	3	
Endurance	105°C rated voltage applied (With the rated ripple current)	Test	φ5 to φ8 : 1,000hours, φ10 : 2,000hours, φ12.5 to φ18 : 3,000hours								
		ΔC/C	Within ±25% of the initial value								
		tanδ	Less than 200% of the specified value								
		LC	Less than the specified value								

Dimensions

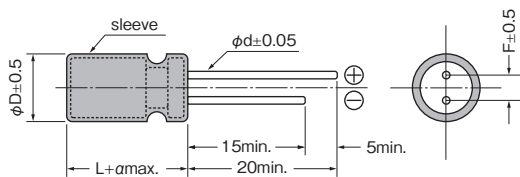
 $\alpha : L < 20 \quad \alpha = 1.5, L \geq 20 \quad \alpha = 2.0$

 A pressure relief vent is provided for $\phi D = 6.3$ or bigger

(Unit : mm)

φD	5	6.3	8	10	12.5	16	18
F	2.0	2.5	3.5	5.0	5.0	7.5	7.5
φd	0.5	0.5	0.6	0.6	0.6	0.8	0.8

Size, Impedance, Rated Ripple Current

Case size φD×L (mm)	Items	6.3			10		
		Capacitance (µF)	Impedance (Ωmax.) (20°C/100kHz)	Rated ripple current (mA rms) (105°C/100kHz)	Capacitance (µF)	Impedance (Ωmax.) (20°C/100kHz)	Rated ripple current (mA rms) (105°C/100kHz)
5×11		220	1.4	160	100	1.4	150
6.3×11		330	0.58	240	220	0.58	240
6.3×11		470	0.55	250	330	0.55	250
8×11.5		1000	0.26	450	470	0.39	370
10×12.5					1000	0.16	560
10×16		2200	0.12	760			
10×20		3300	0.10	900	2200	0.10	900
12.5×20		4700	0.072	1100	3300	0.074	1100
12.5×25		6800	0.054	1420	4700	0.054	1420
16×25		10000	0.043	1700	6800	0.043	1700
16×31.5					10000	0.035	1950
16×35.5		15000	0.032	2100			
18×35.5					15000	0.028	2400

Part number

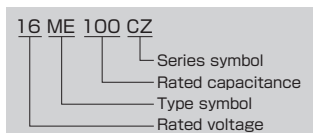

■ Size, Impedance, Rated Ripple Current

Case size φD×L(mm)	Items	16			25		
		Capacitance (μF)	Impedance(Ωmax.) (20°C/100kHz)	Rated ripple current(mArms) (105°C/100kHz)	Capacitance (μF)	Impedance(Ωmax.) (20°C/100kHz)	Rated ripple current(mArms) (105°C/100kHz)
5×11		100	1.4	150	47	1.4	150
6.3×11		220	0.55	240	100	0.60	240
8×11.5		330	0.35	370	220	0.39	370
8×11.5		470	0.28	450	330	0.34	400
10×12.5					470	0.17	560
10×16		1000	0.13	760			
10×20					1000	0.10	900
12.5×20		2200	0.075	1100			
12.5×25		3300	0.054	1320	2200	0.062	1320
16×25		4700	0.043	1600	3300	0.043	1600
16×31.5		6800	0.035	1900	4700	0.035	1900
18×35.5		10000	0.028	2300	6800	0.028	2200

Case size φD×L(mm)	Items	35			50		
		Capacitance (μF)	Impedance(Ωmax.) (20°C/100kHz)	Rated ripple current(mArms) (105°C/100kHz)	Capacitance (μF)	Impedance(Ωmax.) (20°C/100kHz)	Rated ripple current(mArms) (105°C/100kHz)
5×11					2.2	5.5	40
5×11					3.3	4.0	50
5×11					4.7	2.8	80
5×11					10	2.3	90
5×11		33	2.1	120	22	2.2	110
5×11		47	2.1	140	33	2.1	120
6.3×11		100	1.1	180	47	1.1	180
8×11.5		220	0.46	360	100	0.55	310
10×12.5		330	0.26	500	220	0.30	500
10×16		470	0.18	650	330	0.20	650
10×20					470	0.13	800
12.5×20		1000	0.11	900			
12.5×25					1000	0.10	1100
16×25		2200	0.056	1400			
16×31.5					2200	0.055	1650
16×35.5		3300	0.038	1800			
18×35.5		4700 ★	0.035	2000	3300	0.035	2000

★ Available 40V(40ME4700CZ)

Case size φD×L(mm)	Items	63			100		
		Capacitance (μF)	Impedance(Ωmax.) (20°C/100kHz)	Rated ripple current(mArms) (105°C/100kHz)	Capacitance (μF)	Impedance(Ωmax.) (20°C/100kHz)	Rated ripple current(mArms) (105°C/100kHz)
5×11		2.2	8.3	42	2.2	11	42
5×11		3.3	6.0	58	3.3	8.0	58
5×11		4.7	4.2	64	4.7	5.6	64
5×11		10	2.8	90			
5×11		22	2.4	140			
6.3×11		33	1.4	200	10	1.7	108
6.3×11		47	1.3	240			
8×11.5					22	0.83	235
8×12.5		100	0.60	300	33	0.60	300
10×12.5					47	0.39	330
10×16		220	0.22	520			
10×20		330	0.17	765	100	0.24	450
12.5×20		470	0.14	960			
12.5×25					220	0.15	700
16×25		1000	0.065	1100	330	0.090	950
16×30					470	0.085	1100

Please refer to page 14 for ripple current frequency coefficients.

ME-CA Series

Small

Low Impedance



- 105°C 1,000 to 3,000hours
- Solvent proof (within 5 minutes)

Specifications

Items	Condition	Specifications					
Rated voltage (V)	—	6.3	10	16	25	35	50
Surge voltage (V)	Room temperature	8.0	13	20	32	44	63
Category temperature range (°C)	—	-55 to +105					
Capacitance tolerance (%)	120Hz/20°C	M : ±20					
Dissipation Factor (tan δ)	tanδ (max.) 120Hz/20°C	0.28	0.24	0.20	0.16	0.14	0.12
Leakage current (LC)	μA/after 2minutes (max.), 20°C	Exceeding 1,000μF, +0.02 every 1,000μF					
Impedance ratio at low temperature	Based on the value at 120Hz, +20°C	-40°C Z/Z _{20°C}	3	3	2	2	2
		-55°C Z/Z _{20°C}	6	5	4	4	3
Endurance	105°C rated voltage applied (With the rated ripple current)	Test	φ5 to φ8 : 1,000hours, φ10 : 2,000hours, φ12.5 to φ16 : 3,000hours				
		ΔC/C	Within ±25% of the initial value				
		tanδ	Less than 200% of the specified value				
		LC	Less than the specified value				

Dimensions

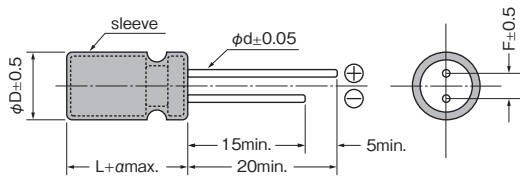

$$\alpha : L < 20 \quad \alpha = 1.5, \quad L \geq 20 \quad \alpha = 2.0$$

A pressure relief vent is provided for φD=6.3 or bigger

(Unit : mm)

φD	5	6.3	8	10	12.5	16
F	2.0	2.5	3.5	5.0	5.0	7.5
φd	0.5	0.5	0.6	0.6	0.6	0.8

Size, Impedance, Rated Ripple Current

Case size φD×L (mm)	Items	6.3			10		
		Capacitance (μF)	Impedance (Ωmax.) (20°C/100kHz)	Rated ripple current (mA _{rms}) (105°C/10k to 200kHz)	Capacitance (μF)	Impedance (Ωmax.) (20°C/100kHz)	Rated ripple current (mA _{rms}) (105°C/10k to 200kHz)
5×11		220	0.50	180			
6.3×11		330	0.30	280	220	0.30	280
6.3×11		470	0.24	280	330	0.24	280
8×11.5		1000	0.15	560	470	0.16	410
10×12.5					1000	0.086	710
10×16		2200	0.066	950			
10×20		3300	0.047	1150	2200	0.047	1150
12.5×20		4700	0.042	1460	3300	0.042	1460
12.5×25		6800	0.031	1780	4700	0.031	1780
16×25		10000	0.026	2000	6800	0.026	2000
16×31.5					10000	0.022	2200
16×35.5		15000	0.022	2200			

Size, Impedance, Rated Ripple Current

Case size Items φD×L(mm)	16			25			
	V	Capacitance (μF)	Impedance(Ωmax.) (20°C/100kHz)	Rated ripple current(mArms) (105°C/10k to 200kHz)	Capacitance (μF)	Impedance(Ωmax.) (20°C/100kHz)	Rated ripple current(mArms) (105°C/10k to 200kHz)
5×11		100	0.50	180			
6.3×11		220	0.24	280	100	0.30	280
8×11.5		330	0.16	410	220	0.16	410
8×11.5		470	0.15	560	330	0.15	560
10×12.5					470	0.086	710
10×16		1000	0.066	950			
10×20					1000	0.047	1150
12.5×20		2200	0.042	1460			
12.5×25		3300	0.035	1780	2200	0.035	1780
16×25		4700	0.026	2000	3300	0.026	2000
16×31.5		6800	0.022	2200	4700	0.022	2200

Case size Items φD×L(mm)	35			50			
	V	Capacitance (μF)	Impedance(Ωmax.) (20°C/100kHz)	Rated ripple current(mArms) (105°C/10k to 200kHz)	Capacitance (μF)	Impedance(Ωmax.) (20°C/100kHz)	Rated ripple current(mArms) (105°C/10k to 200kHz)
5×11					2.2	3.0	45
5×11					3.3	2.7	55
5×11					4.7	2.0	90
5×11					10	1.7	110
5×11		33	0.72	180	22	1.2	120
5×11		47	0.50	180	33	0.95	130
6.3×11		100	0.24	280	47	0.56	190
8×11.5		220	0.15	560	100	0.30	320
10×12.5		330	0.086	710	220	0.16	520
10×16		470	0.066	950	330	0.12	670
10×20					470	0.088	820
12.5×20		1000	0.042	1460			
12.5×25					1000	0.053	1200
16×25		2200	0.026	2000			
16×31.5					2200	0.029	1750
16×35.5		3300	0.022	2200			

Please refer to page 14 for ripple current frequency coefficients.

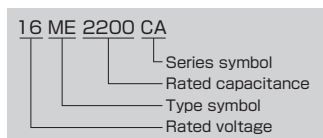
Part number

 Radial Lead Type
Aluminum Electrolytic Capacitors

- ME-SZ
- ME-SAX
- ME-SWG
- ME-LS
- ME-CZ
- ME-CA
- ME-CX
- ME-AX
- ME-WX
- ME-WA
- ME-WL
- ME-WG
- ME-FX
- ME-FC-FD
- ME-FH
- ME-SWN
- ME-HWN

ME-CX Series

Small, Long Life

Low Impedance



- 105°C 2,000 to 7,000hours
- Solvent proof (within 5 minutes)

Specifications

Items	Condition	Specifications					
Rated voltage (V)	—	6.3	10	16	25	35	
Surge voltage (V)	Room temperature	8.0	13	20	32	44	
Category temperature range (°C)	—	-55 to +105					
Capacitance tolerance (%)	120Hz/20°C	M: ±20					
Dissipation Factor (tan δ)	tanδ (max.) 120Hz/20°C	0.22	0.19	0.16	0.14	0.12	
		Exceeding 1,000μF, +0.02 every 1,000μF					
Leakage current (LC)	μA/after 2minutes (max.), 20°C	0.01CV					
Impedance ratio at low temperature	Based on the value at 120Hz, +20°C	-40°C Z/Z _{20°C}	3	2	2	2	2
		-55°C Z/Z _{20°C}	4	4	3	3	3
Endurance	105°C rated voltage applied (With the rated ripple current)	Test	φ5 to φ6.3 : 2,000hours, φ8 : 3,000hours, φ10 : 4,000hours, φ12.5 : 5,000hours, φ16 to φ18 : 7,000hours				
		ΔC/C	Within ±25% of the initial value				
		tanδ	Less than 200% of the specified value				
		LC	Less than the specified value				

Dimensions

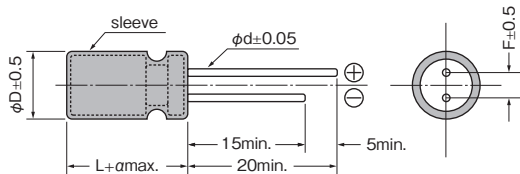

$\alpha : L < 20 \quad \alpha = 1.5, L \geq 20 \quad \alpha = 2.0$

A pressure relief vent is provided for φD=6.3 or bigger

(Unit : mm)

φD	5	6.3	8	10	12.5	16	18
F	2.0	2.5	3.5	5.0	5.0	7.5	7.5
φd	0.5	0.5	0.6	0.6	0.6★	0.8	0.8

★φ12.5×30:φd=0.8

Size, Impedance, Rated Ripple Current

Case size φD×L (mm)	Items	6.3			10		
		Capacitance (μF)	Impedance (Ωmax.) (20°C/100kHz)	Rated ripple current (mA rms) (105°C/10k to 200kHz)	Capacitance (μF)	Impedance (Ωmax.) (20°C/100kHz)	Rated ripple current (mA rms) (105°C/10k to 200kHz)
5×11		180	0.34	205	150	0.34	205
6.3×11		330	0.17	330	270	0.17	330
6.3×11		390	0.17	330	330	0.17	330
8×11.5		680	0.11	580	470	0.11	580
8×11.5					560	0.11	580
10×12.5		1200	0.063	900	820	0.063	900
10×16		1500	0.049	1200	1000	0.049	1200
10×16					1200	0.049	1200
10×20		2200	0.036	1450	1500	0.036	1450
10×22		2700	0.036	1500	1800	0.036	1500
12.5×20		3900	0.035	1660	2700	0.035	1660
12.5×25		4700	0.027	2000	3900	0.027	2000
12.5×25		5600	0.027	2000			
12.5×30	★1	6800	0.024	2450	★1 4700	0.024	2450
16×21	★2	5600	0.032	2000	★2 3900	0.032	2000
16×25		6800	0.022	2560	4700	0.022	2560
16×25		8200	0.022	2560	5600	0.022	2560
16×31.5		10000	0.017	3010	6800	0.017	3010
16×31.5					8200	0.017	3010
16×35.5		12000	0.016	3150	10000	0.016	3150
18×21	★2	6800	0.030	2490	★2 5600	0.030	2490
18×25	★2	10000	0.022	2740	★2 6800	0.022	2740
18×30.5	★2	12000	0.017	3330	★2 10000	0.017	3330
18×35.5		15000	0.016	3680	12000	0.016	3680

★1 CXL ★2 CXS

■ Size, Impedance, Rated Ripple Current

Case size φD×L(mm)	Items	16			25		
		Capacitance (μF)	Impedance(Ωmax.) (20°C/100kHz)	Rated ripple current(mArms) (105°C/10k to 200kHz)	Capacitance (μF)	Impedance(Ωmax.) (20°C/100kHz)	Rated ripple current(mArms) (105°C/10k to 200kHz)
5×11		100	0.34	205	68	0.34	205
6.3×11		180	0.17	330	120	0.17	330
6.3×11		220	0.17	330	150	0.17	330
8×11.5		330	0.11	580	220	0.11	580
10×12.5		560	0.063	900	390	0.063	900
10×12.5					★2 470	0.063	900
10×16		820	0.049	1200	560	0.049	1200
10×16					★2 680	0.049	1200
10×20		1000	0.036	1450	680	0.036	1450
10×20					820	0.036	1450
10×20					★2 1000	0.036	1450
10×22		1200	0.036	1500	1000	0.036	1500
12.5×20		1500	0.035	1660	1200	0.035	1660
12.5×20		1800	0.035	1660	1500	0.035	1660
12.5×25		2200	0.027	2000	1800	0.027	2000
12.5×25		2700	0.027	2000	2200	0.027	2000
12.5×30	★1	3300	0.024	2450	★1 2200	0.024	2450
16×21	★2	2700	0.032	2000	★2 1800	0.032	2000
16×25		3300	0.022	2560	2700	0.022	2560
16×25		3900	0.022	2560			
16×31.5		4700	0.017	3010	3300	0.017	3010
16×31.5		5600	0.017	3010			
16×35.5		6800	0.016	3150	3900	0.016	3150
18×21	★2	3300	0.030	2490	★2 2200	0.030	2490
18×25	★2	4700	0.022	2740	★2 3300	0.022	2740
18×30.5					★2 3900	0.017	3330
18×35.5					4700	0.016	3680
18×35.5		8200	0.016	3680	5600	0.016	3680

Case size φD×L(mm)	Items	35		
		Capacitance (μF)	Impedance(Ωmax.) (20°C/100kHz)	Rated ripple current(mArms) (105°C/10k to 200kHz)
5×11		47	0.34	205
6.3×11		100	0.17	330
8×11.5		150	0.11	580
10×12.5		270	0.063	900
10×12.5	★2	330	0.063	900
10×16		330	0.049	1200
10×16		390	0.049	1200
10×16	★2	470	0.049	1200
10×20		470	0.036	1450
10×20		560	0.036	1450
10×20	★2	680	0.036	1450
10×22		680	0.036	1500
12.5×20		820	0.035	1660
12.5×20		1000	0.035	1660
12.5×25		1200	0.027	2000
12.5×25		1500	0.027	2000
12.5×30	★1	1500	0.024	2450
16×21	★2	1200	0.032	2000
16×25		1800	0.022	2560
16×31.5		2700	0.017	3010
16×35.5		3300	0.016	3150
18×21	★2	1500	0.030	2490
18×25		2200	0.022	2740
18×30.5	★2	3300	0.017	3330
18×35.5		3900	0.016	3680

Please refer to page 14 for ripple current frequency coefficients.

★1 CXL
★2 CXS

Radial
Lead Type
Aluminum Electrolytic
Capacitors

- ME-SZ
- ME-SAX
- ME-SWG
- ME-LS
- ME-CZ
- ME-CA
- ME-CX
- ME-AX
- ME-WX
- ME-WA
- ME-WL
- ME-WG
- ME-FX
- ME-FC-FD
- ME-FH
- ME-SWN
- ME-HWN

■ Part number

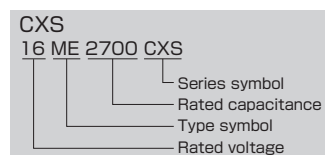
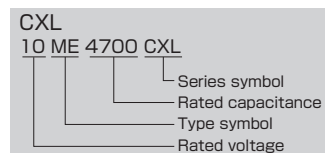
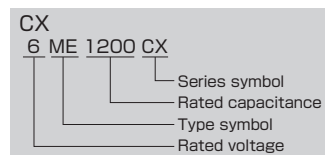

ME-AX Series

Long Life

Low Impedance



- 105°C 2,500 to 10,000hours
- Solvent proof (within 5 minutes)

Specifications

Items	Condition	Specifications									
Rated voltage (V)	—	6.3	10	16	25	35	50	63	100		
Surge voltage (V)	Room temperature	8.0	13	20	32	44	63	79	125		
Category temperature range (°C)	—	-55 to +105								-40 to +105	
Capacitance tolerance (%)	120Hz/20°C	M : ±20									
Dissipation Factor (tan δ)	tanδ (max.) 120Hz/20°C	0.22	0.19	0.16	0.14	0.12	0.10	0.10	0.10		
		Exceeding 1,000μF, +0.02 every 1,000μF									
Leakage current (LC)	μA/after 2minutes (max.), 20°C	The greater value of either 0.01CV or 3									
Impedance ratio at low temperature	Based on the value at 120Hz, +20°C	-40°C Z/Z _{20°C}	3	2	2	2	2	2	2	2	
		-55°C Z/Z _{20°C}	4	4	3	3	3	2	2	—	
Endurance	105°C rated voltage applied (With the rated ripple current)	Test	φ5 : 2,500hours, φ6.3 : 3,000hours, φ8×11.5, φ8×12.5 : 3,500hours, φ10 : 5,000hours, φ12.5 : 7,000hours, φ16 to φ18 : 10,000hours								
		ΔC/C	Within ±20% of the initial value								
		tanδ	Less than 200% of the specified value								
		LC	Less than the specified value								

Dimensions

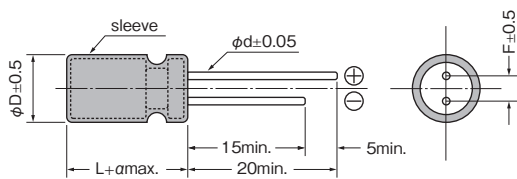

(Unit : mm)

φD	5	6.3	8	10	12.5	16	18
F	2.0	2.5	3.5	5.0	5.0	7.5	7.5
φd	0.5	0.5	0.6	0.6	0.6	0.8	0.8

α : L<20 α=1.5, L≥20 α=2.0

A pressure relief vent is provided for φD=6.3 or bigger

Size, Impedance, Rated Ripple Current

Case size φD×L (mm)	Items	6.3			10		
		Capacitance (μF)	Impedance (Ωmax.) (20°C/100kHz)	Rated ripple current (mA _{rms}) (105°C/10k to 200kHz)	Capacitance (μF)	Impedance (Ωmax.) (20°C/100kHz)	Rated ripple current (mA _{rms}) (105°C/10k to 200kHz)
5×11		150	0.42	190	100	0.42	190
6.3×11		270	0.22	300	220	0.22	300
8×11.5		470	0.11	560	330	0.11	560
8×12.5		560	0.11	570	390	0.11	570
10×12.5		820	0.085	800	680	0.085	800
10×16		1200	0.062	1050	820	0.062	1050
10×20		1500	0.044	1250	1200	0.044	1250
10×22		1800	0.039	1450	1500	0.039	1450
12.5×20		2700	0.038	1600	2200	0.038	1600
12.5×25		3900	0.029	1800	2700	0.029	1800
16×25		5600	0.022	2100	3900	0.022	2100
16×31.5		8200	0.018	2350	5600	0.018	2350
16×35		10000	0.018	2550	6800	0.018	2550
18×35.5		12000	0.018	2800	8200	0.018	2800

★1 AXL ★2 AXS

Part number

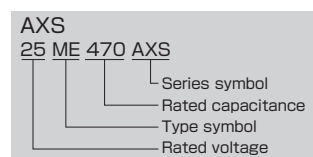
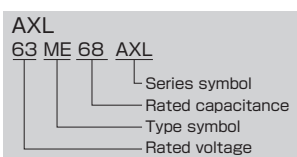
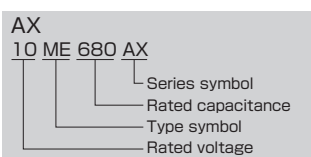

■ Size, Impedance, Rated Ripple Current

V		16			25		
Case size φD×L(mm)	Items	Capacitance (μF)	Impedance(Ωmax.) (20°C/100kHz)	Rated ripple current(mArms) (105°C/10k to 200kHz)	Capacitance (μF)	Impedance(Ωmax.) (20°C/100kHz)	Rated ripple current(mArms) (105°C/10k to 200kHz)
5×11		68	0.42	190	47	0.42	190
6.3×11		150	0.22	300	100	0.22	300
8×11.5		220	0.11	560	150	0.11	560
8×12.5		270	0.11	570	180	0.11	570
10×12.5		470	0.085	800	270	0.085	800
10×16		560	0.062	1050	390	0.062	1050
10×16		680	0.062	1050	★2 470	0.068	1050
10×20		820	0.044	1250	560	0.044	1250
10×22		1000	0.039	1450	680	0.039	1450
12.5×20		1200	0.038	1600	1000	0.038	1600
12.5×25		1800	0.029	1800	1200	0.029	1800
16×25		2700	0.022	2100	1800	0.022	2100
16×31.5		3900	0.018	2350	2700	0.018	2350
16×35		4700	0.018	2550	3300	0.018	2550
18×35.5		5600	0.018	2800	3900	0.018	2800

V		35			50		
Case size φD×L(mm)	Items	Capacitance (μF)	Impedance(Ωmax.) (20°C/100kHz)	Rated ripple current(mArms) (105°C/10k to 200kHz)	Capacitance (μF)	Impedance(Ωmax.) (20°C/100kHz)	Rated ripple current(mArms) (105°C/10k to 200kHz)
5×11		4.7	1.2	115	4.7	2.0	90
5×11		10	0.90	140	10	1.7	110
5×11		22	0.42	190	15	1.2	130
5×11		33	0.42	190	22	0.70	160
6.3×11		47	0.22	300	33	0.43	220
6.3×11		68	0.22	300	47	0.43	220
8×11.5		100	0.11	560	68	0.26	360
8×12.5		120	0.11	570	82	0.24	400
10×12.5		220	0.085	800	120	0.16	550
10×16		270	0.062	1050	180	0.12	760
10×20		330	0.044	1250	270	0.088	950
10×22		470	0.039	1450	330	0.072	1000
12.5×20		680	0.038	1600	470	0.059	1200
12.5×25		1000	0.029	1800	560	0.045	1400
16×25		1500	0.022	2100	1000	0.039	1750
16×31.5		2200	0.018	2350	1200	0.025	2100
16×35		★1 2200	0.018	2550	1500	0.025	2300
18×35.5		2700	0.018	2800	1800	0.024	2400

V		63			100		
Case size φD×L(mm)	Items	Capacitance (μF)	Impedance(Ωmax.) (20°C/100kHz)	Rated ripple current(mArms) (105°C/10k to 200kHz)	Capacitance (μF)	Impedance(Ωmax.) (20°C/100kHz)	Rated ripple current(mArms) (105°C/10k to 200kHz)
5×11		18	1.6	140	5.6	2.7	120
6.3×11		33	0.90	200	12	1.4	170
8×11.5		68	0.52	275	22	0.81	230
8×12.5		★1 68	0.47	300	★1 22	0.79	250
10×12.5		120	0.26	420	39	0.39	360
10×16		150	0.20	525	47	0.35	420
10×20		220	0.15	765	68	0.24	630
10×22		270	0.12	840	82	0.21	700
12.5×20		330	0.10	960	100	0.15	800
12.5×25		470	0.064	1200	150	0.11	920
16×25		680	0.052	1500	220	0.071	1100
16×31.5		1000	0.042	1750	330	0.049	1490
16×35		1200	0.036	1920	390	0.043	1630
18×35.5		1500	0.033	2000	470	0.038	1700

Please refer to page 14 for ripple current frequency coefficients.

★1 AXL ★2 AXS

 Radial Lead Type
Aluminum Electrolytic Capacitors

- ME-SZ
- ME-SAX
- ME-SWG
- ME-LS
- ME-CZ
- ME-CA
- ME-CX
- ME-AX
- ME-WX
- ME-WA
- ME-WL
- ME-WG
- ME-FX
- ME-FC-FD
- ME-FH
- ME-SWN
- ME-HWN

ME-WX Series

High Ripple Current

Low Impedance



- 105°C 2,000 to 5,000hours
- Non solvent proof

Specifications

Items	Condition	Specifications						
Rated voltage (V)	—	6.3	10	16	25	35	50	
Surge voltage (V)	Room temperature	8.0	13	20	32	44	63	
Category temperature range (°C)	—	-40 to +105						
Capacitance tolerance (%)	120Hz/20°C	M : ±20						
Dissipation Factor(tan δ)	tanδ(max.) 120Hz/20°C	0.22	0.19	0.16	0.14	0.12	0.10	
		Exceeding 1,000μF, +0.02 every 1,000μF						
Leakage current(LC)	μA/after 2minutes (max.), 20°C	0.01CV						
Impedance ratio at low temperature	Based on the value at 120Hz, +20°C	-25°C Z/Z _{20°C}	2	2	2	2	2	2
		-40°C Z/Z _{20°C}	3	3	3	3	3	3
Endurance	105°C rated voltage applied (With the rated ripple current)	Test	φ5 to φ6.3 : 2,000hours, φ8 : 3,000hours, φ10 : 4,000hours, φ12.5 to φ16 : 5,000hours					
		ΔC/C	Within ±25% of the initial value					
		tanδ	Less than 200% of the specified value					
		LC	Less than the specified value					

Dimensions

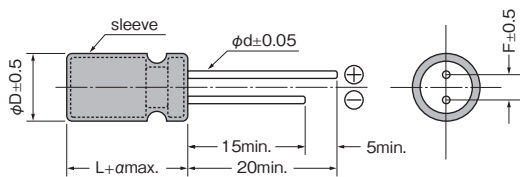

$\alpha : L < 20 \quad \alpha = 1.5, L \geq 20 \quad \alpha = 2.0$

A pressure relief vent is provided for φD=6.3 or bigger

(Unit : mm)

φD	5	6.3	8	10	12.5	16
F	2.0	2.5	3.5	5.0	5.0	7.5
φd	0.5	0.5	0.6	0.6	0.6★	0.8

★φ12.5×30:φd=0.8

Size, Impedance, Rated Ripple Current

Case size φD×L (mm)	6.3			10		
	Capacitance (μF)	Impedance(Ωmax.) (20°C/100kHz)	Rated ripple current(mArms) (105°C/100kHz)	Capacitance (μF)	Impedance(Ωmax.) (20°C/100kHz)	Rated ripple current(mArms) (105°C/100kHz)
5×11	150	0.30	250	100	0.30	250
6.3×11	330	0.13	405	220	0.13	405
8×11.5	560	0.072	760	470	0.072	760
10×12.5	1000	0.053	1030	680	0.053	1030
10×16	1200	0.038	1430	1000	0.038	1430
10×20	1500	0.023	1820	1200	0.023	1820
10×20	2200	0.023	1820	1500	0.023	1820
10×23	★2 2200	0.022	2150	★2 1500	0.022	2150
12.5×20	3300	0.021	2360	2200	0.021	2360
12.5×25	3900	0.018	2770	3300	0.018	2770
12.5×30	4700	0.016	3290	3900	0.016	3290
16×21	5600	0.018	3140	★1 3900	0.018	3140
16×25	6800	0.016	3460	5600	0.016	3460

★1 WXS ★2 WXV

- ME-SZ
- ME-SAX
- ME-SWG
- ME-LS
- ME-CZ
- ME-CA
- ME-CX
- ME-AX
- ME-WX**
- ME-WA
- ME-WL
- ME-WG
- ME-FX
- ME-FC-FD
- ME-FH
- ME-SWN
- ME-HWN

■ Size, Impedance, Rated Ripple Current

Case size Items φD×L(mm)	16			25			
	V	Capacitance (μF)	Impedance (Ωmax.) (20°C/100kHz)	Rated ripple current (mA rms) (105°C/100kHz)	Capacitance (μF)	Impedance (Ωmax.) (20°C/100kHz)	Rated ripple current (mA rms) (105°C/100kHz)
5×11		56	0.30	250	47	0.30	250
6.3×11		120	0.13	405	100	0.13	405
8×11.5		330	0.072	760	220	0.072	760
10×12.5		470	0.053	1030	★1 330	0.053	1030
10×16		680	0.038	1430	470	0.038	1430
10×20		1000	0.023	1820	680	0.023	1820
10×20		1200	0.023	1820	820	0.023	1820
10×23		★2 1200	0.022	2150	★2 820	0.022	2150
12.5×20		1500	0.021	2360	1000	0.021	2360
12.5×25		2200	0.018	2770	1500	0.018	2770
12.5×30		2700	0.016	3290	1800	0.016	3290
16×21		★1 2700	0.018	3140	★1 1800	0.018	3140
16×25		3900	0.016	3460	2700	0.016	3460

Case size Items φD×L(mm)	35			50			
	V	Capacitance (μF)	Impedance (Ωmax.) (20°C/100kHz)	Rated ripple current (mA rms) (105°C/100kHz)	Capacitance (μF)	Impedance (Ωmax.) (20°C/100kHz)	Rated ripple current (mA rms) (105°C/100kHz)
5×11		33	0.30	250	22	0.34	238
6.3×11		56	0.13	405	47	0.14	385
8×12.5		★2 150	0.072	760	100	0.074	724
10×12.5		★1 220	0.053	1030	150	0.061	979
10×16		330	0.038	1430	220	0.042	1370
10×20		470	0.023	1820	270	0.030	1580
10×23		★2 560	0.022	2150	330	0.028	1870
12.5×20		680	0.021	2360	470	0.027	2050
12.5×25		1000	0.018	2770	560	0.023	2410
12.5×30		1200	0.016	3290	680	0.021	2860
16×21		★1 1200	0.018	3140	820	0.023	2730
16×25		1800	0.016	3460	1000	0.021	3010

Please refer to page 14 for ripple current frequency coefficients.

★1 WXS ★2 WXV

■ Part number

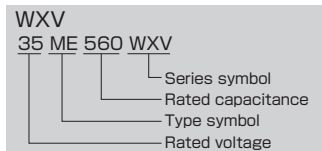
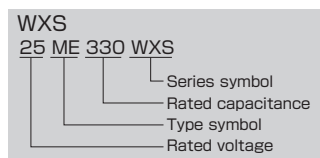
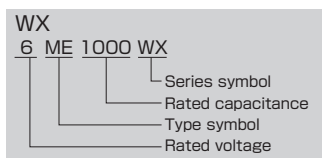

ME-WA Series

105°C, Small, Long Life

Low Impedance, High Ripple Current



- 105°C 8,000 to 10,000hours
- Non solvent proof

Specifications

Items	Condition	Specifications								
Rated voltage (V)	—	6.3	10	16	25	35	50	63		
Surge voltage (V)	Room temperature	8.0	13	20	32	44	63	79		
Category temperature range (°C)	—	-40 to +105								
Capacitance tolerance (%)	120Hz/20°C	M : ±20								
Dissipation Factor (tan δ)	tanδ(max.) 120Hz/20°C	0.22	0.19	0.16	0.14	0.12	0.10	0.10		
		Exceeding 1,000μF, +0.02 every 1,000μF								
Leakage current(LC)	μA/after 2minutes (max.), 20°C	0.03CV								
Impedance ratio at low temperature	Based on the value at 120Hz, +20°C	-25°C Z/Z _{20°C}	2	2	2	2	2	2	2	
		-40°C Z/Z _{20°C}	3	3	3	3	3	3	3	
Endurance	105°C rated voltage applied (With the rated ripple current)	Test	φ8 : 8,000hours, φ10 to φ16 : 10,000hours							
		ΔC/C	Within ±25% of the initial value(6.3V, 10V : ±30%)							
		tanδ	Less than 200% of the specified value							
		LC	Less than the specified value							

Dimensions

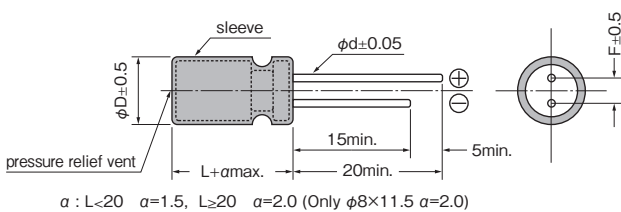

(Unit : mm)

φD	8	10	12.5	16
F	3.5	5.0	5.0	7.5
φd	0.6	0.6	0.6★	0.8

★φ12.5×30:φd=0.8

Size, Impedance, Rated Ripple Current

Case size φD×L(mm)	Items	6.3			10		
		Capacitance (μF)	Impedance(Ωmax.) (20°C/100kHz)	Rated ripple current(mArms) (105°C/100kHz)	Capacitance (μF)	Impedance(Ωmax.) (20°C/100kHz)	Rated ripple current(mArms) (105°C/100kHz)
8×11.5		820	0.059	945	680	0.059	945
10×12.5		1200	0.043	1330	1000	0.043	1330
10×16		1800	0.030	1760	1500	0.030	1760
10×20		2200	0.021	1960	1800	0.021	1960
10×22		2700	0.020	2250	2200	0.020	2250
12.5×20		3900	0.019	2480	3300	0.019	2480
12.5×25		4700	0.016	2900	3900	0.016	2900
12.5×30		5600	0.014	3450	★1 4700	0.014	3450
16×21		6800	0.018	3250	4700	0.018	3250
16×25		8200	0.014	3630	6800	0.014	3630

★1 WAL

■ Size, Impedance, Rated Ripple Current

Case size φD×L(mm)	Items	16			25		
		V	Capacitance (μF)	Impedance(Ωmax.) (20°C/100kHz)	Rated ripple current(mArms) (105°C/100kHz)	Capacitance (μF)	Impedance(Ωmax.) (20°C/100kHz)
8×11.5		470	0.059	945	330	0.059	945
10×12.5		680	0.043	1330	470	0.043	1330
10×16		1000	0.030	1760	680	0.030	1760
10×20		1500	0.021	1960	820	0.021	1960
10×22		1800	0.020	2250	1000	0.020	2250
12.5×20		2200	0.019	2480	1500	0.019	2480
12.5×25		2700	0.016	2900	1800	0.016	2900
12.5×30	★1	3300	0.014	3450	★1 2200	0.014	3450
16×21		3300	0.018	3250	2200	0.018	3250
16×25		4700	0.014	3630	3300	0.014	3630

Case size φD×L(mm)	Items	35			50		
		V	Capacitance (μF)	Impedance(Ωmax.) (20°C/100kHz)	Rated ripple current(mArms) (105°C/100kHz)	Capacitance (μF)	Impedance(Ωmax.) (20°C/100kHz)
8×11.5		220	0.059	945	100	0.074	724
10×12.5		330	0.043	1330	150	0.061	979
10×16		470	0.030	1760	220	0.042	1370
10×20		560	0.021	1960	270	0.030	1580
10×22		680	0.020	2250	330	0.028	1870
12.5×20		1000	0.019	2480	470	0.027	2050
12.5×25		1200	0.016	2900	560	0.023	2410
12.5×30	★1	1500	0.014	3450	680	0.021	2860
16×21		1500	0.018	3250	820	0.023	2730
16×25		2200	0.014	3630	1000	0.021	3010

Case size φD×L(mm)	Items	63		
		V	Capacitance (μF)	Impedance(Ωmax.) (20°C/100kHz)
8×11.5		82	0.22	525
10×12.5		120	0.15	725
10×16		180	0.11	998
10×20		270	0.078	1200
12.5×20		390	0.060	1570
12.5×25		470	0.043	1990
12.5×30	★1	560	0.035	2410
16×21		560	0.043	2100
16×25		820	0.032	2730

Please refer to page 14 for ripple current frequency coefficients. ★1 WAL

■ Part number

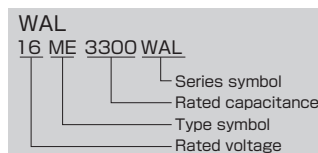
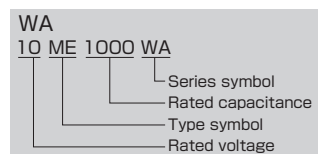

Radial Lead Type
Aluminum Electrolytic Capacitors

- ME-SZ
- ME-SAX
- ME-SWG
- ME-LS
- ME-CZ
- ME-CA
- ME-CX
- ME-AX
- ME-WX
- ME-WA
- ME-WL
- ME-WG
- ME-FX
- ME-FC-FD
- ME-FH
- ME-SWN
- ME-HWN

ME-WL Series

Small, Long Life

Low Impedance



- 105°C 4,000 to 5,000hours
- Non solvent proof

Specifications

Items	Condition	Specifications								
Rated voltage (V)	—	6.3	10	16	25	35	50	63	100	
Surge voltage (V)	Room temperature	8.0	13	20	32	44	63	79	125	
Category temperature range (°C)	—	-40 to +105								
Capacitance tolerance (%)	120Hz/20°C	M : ±20								
Dissipation Factor (tan δ)	tanδ (max.) 120Hz/20°C	0.22	0.19	0.16	0.14	0.12	0.10	0.10	0.10	
Leakage current (LC)	μA/after 2minutes (max.), 20°C	The greater value of either 0.01CV or 3								
Impedance ratio at low temperature	Based on the value at 120Hz, +20°C	-25°C Z/Z _{20°C}	4	3	2	2	2	2	2	
		-40°C Z/Z _{20°C}	8	6	4	3	3	3	3	
Endurance	105°C rated voltage applied (With the rated ripple current)	Test	4,000hours		5,000hours					
		ΔC/C	Within ±25% of the initial value							
		tanδ	Less than 200% of the specified value							
		LC	Less than the specified value							

Dimensions

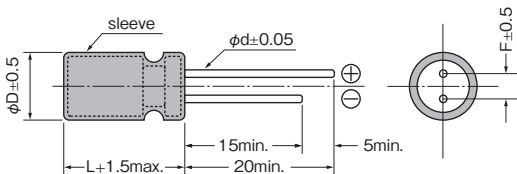

A pressure relief vent is provided for φD=6.3 or bigger

(Unit : mm)

	5	6.3
φD	5	6.3
F	2.0	2.5
φd	0.5	0.5

Size, Impedance, Rated Ripple Current

μF	V	6.3			10			16			25		
		47										5×11	0.58
56								5×11	0.69	210			
100					5×11	0.58	210	5×11	0.69	210	6.3×11	0.26	340
120								6.3×11	0.26	340			
150	5×11	0.69	210	5×11	0.69	210							
220				6.3×11	0.26	340	6.3×11	0.26	340				
330	6.3×11	0.26	340	6.3×11	0.26	340							
470	6.3×11	0.26	340										

μF	V	35			50			63			100		
		2.2				5×11	2.50	43					
3.3					5×11	2.20	53						
4.7					5×11	1.90	88						
6.8											5×11	1.40	125
10					5×11	1.50	100						
15								5×11	1.06	165	6.3×11	0.57	205
18								5×11	1.06	165			
22					5×11	0.84	180	6.3×11	0.42	265			
27					5×11	0.84	180						
33	5×11	0.69	210				6.3×11	0.42	265				
47	5×11	0.69	210	6.3×11	0.40	250							
56	6.3×11	0.26	340	6.3×11	0.36	295							
100	6.3×11	0.26	340										

Please refer to page 14 for ripple current frequency coefficients.

Impedance(Ω) max. at 100kHz, 20°C
 Rated ripple current mArms(100kHz, 105°C)
 Case size:φDxL(mm)

Part number

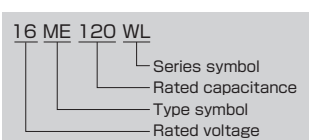

ME-WG Series

Super Low ESR, Small



- 105°C 2,000 to 4,000hours
- Non solvent proof

Specifications

Items	Condition	Specifications				
Rated voltage (V)	—	6.3	10	16	25	
Surge voltage (V)	Room temperature	8.0	13	20	32	
Category temperature range (°C)	—	-40 to +105				
Capacitance tolerance (%)	120Hz/20°C	M : ±20				
Dissipation Factor (tan δ)	tanδ (max.) 120Hz/20°C	0.22	0.19	0.16	0.14	
		Exceeding 1,000μF, +0.02 every 1,000μF				
Leakage current (LC)	μA/after 2minutes (max.), 20°C	0.03CV				
Impedance ratio at low temperature	Based on the value at 120Hz, +20°C	-25°C Z/Z _{20°C}	2	2	2	2
		-40°C Z/Z _{20°C}	3	3	3	3
Endurance	105°C rated voltage applied (With the rated ripple current)	Test	φ8×11.5, φ8×16, φ10×12.5, φ10×16 : 2,000hours, φ10×20, φ10×23 : 4,000hours			
		ΔC/C	Within ±25% of the initial value			
		tanδ	Less than 200% of the specified value			
		LC	Less than the specified value			

Dimensions

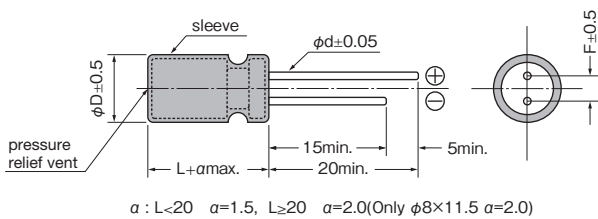

(Unit : mm)

φD	8	10
F	3.5	5.0
φd	0.6	0.6

Size, ESR, Rated Ripple Current

V Items μF	6.3			10			16			25		
	Case size φD×L (mm)	ESR (Qmax.) 20°C/100kHz	Ripple current (mA _{rms}) 105°C/100kHz	Case size φD×L (mm)	ESR (Qmax.) 20°C/100kHz	Ripple current (mA _{rms}) 105°C/100kHz	Case size φD×L (mm)	ESR (Qmax.) 20°C/100kHz	Ripple current (mA _{rms}) 105°C/100kHz	Case size φD×L (mm)	ESR (Qmax.) 20°C/100kHz	Ripple current (mA _{rms}) 105°C/100kHz
220										8×11.5	0.030	1110
330							8×11.5	0.030	1140	8×11.5	0.032	1080
470				8×11.5	0.030	1140	8×11.5	0.036	1140	10×12.5 ★2	0.025	1440
680				8×11.5	0.036	1140	8×16 ★1	0.028	1490	10×16 ★2	0.020	1920
820	8×11.5	0.036	1140				10×12.5	0.026	1540	10×20 ★2	0.016	2180
1000	8×11.5	0.030	1140	8×16 ★1	0.028	1490	10×16	0.019	2000	10×23 ★1	0.016	2180
1200	8×16	0.028	1490	10×12.5	0.026	1540						
1500	10×12.5	0.026	1540	10×16	0.019	2000	10×20	0.013	2550			
	10×16 ★2	0.018	2000									
1800	10×16	0.019	2000	10×20	0.013	2550	10×23	0.012	2800			
2200	10×20	0.013	2550	10×23	0.012	2800						
3300	10×23	0.012	2800									

Please refer to page 14 for ripple current frequency coefficients.

★1 WGL ★2 WGV

Part number

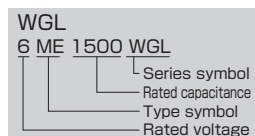
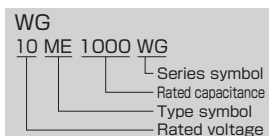

ME-FX Series

Long Life



- 105°C 10,000hours
- Solvent proof(within 5 minutes)

Specifications

Items	Condition	Specifications							
Rated voltage (V)	—	10	16	25	35	50	100		
Surge voltage (V)	Room temperature	13	20	32	44	63	125		
Category temperature range (°C)	—	-40 to +105							
Capacitance tolerance (%)	120Hz/20°C	M : ±20							
Dissipation Factor(tan δ)	tanδ(max.) 120Hz/20°C	0.45	0.35	0.30	0.22	0.19	0.15		
Leakage current(LC)	µA/after 2minutes (max.), 20°C	The greater value of either 0.01CV or 3							
Impedance ratio at low temperature	Based on the value at 120Hz, +20°C	-25°C	Z/Z _{20°C}	8	6	4	4	3	3
Endurance	105°C, 10,000hours rated voltage applied (With the rated ripple current)	△C/C	Within ±25% of the initial value						
		tanδ	Less than 300% of the specified value						
		LC	Less than the specified value						

Dimensions

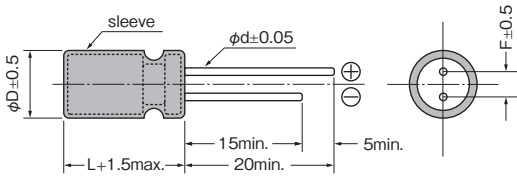

A pressure relief vent is provided for φD=6.3 or bigger

(Unit : mm)

φD	5	6.3	8
F	2.0	2.5	3.5
φd	0.5	0.5	0.6

Size, Rated Ripple Current

µF	V	10	16	25	35	50	100
2.2						5×11	35
3.3						5×11	70
4.7						5×11	80
10						5×11	90
22						5×11	110
33				5×11	130	5×11	130
47			5×11	130	5×11	130	6.3×11
100			6.3×11	210	6.3×11	210	8×11.5
220	6.3×11	210	8×11.5	330	8×11.5	330	8×12.5
330	8×11.5	330	8×11.5	330			
470	8×11.5	330					

Please refer to page 14 for ripple current frequency coefficients.

Case size: φD×L (mm)

Rated ripple current mArms(100kHz, 105°C)

Part number

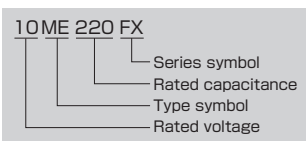

ME-FC·FD Series

105°C, High Voltage

105°C Low Profile, High Voltage



- 105°C 1,000 to 2,000hours
- Non solvent proof

Specifications

Items	Condition	Specifications						
Rated voltage (V)	—	160	200	250	350	400	450	
Surge voltage (V)	Room temperature	200	250	300	400	450	500	
Category temperature range (°C)	—	-40 to +105					-25 to +105	
Capacitance tolerance (%)	120Hz/20°C	M : ±20						
Dissipation Factor (tan δ)	tanδ (max.) 120Hz/20°C	0.20	0.20	0.20	0.25	0.25	0.25	
Leakage current (LC)	μA/after 2minutes (max.) (20°C)	CV ≤ 1.000	0.03CV + 15					
		CV > 1.000	0.02CV + 25					
Impedance ratio at low temperature	Based on the value at 120Hz, +20°C	-25°C Z/Z _{20°C}	3	3	3	4	6	6
		-40°C Z/Z _{20°C}	6	6	6	8	10	—
Endurance	105°C rated voltage applied (With the rated ripple current)	Test	φ5 to φ8 : 1,000hours, φ10 to φ18 : 2,000hours					
		ΔC/C	Within ±20% of the initial value					
		tanδ	Less than 200% of the specified value					
		LC	Less than the specified value					

Dimensions

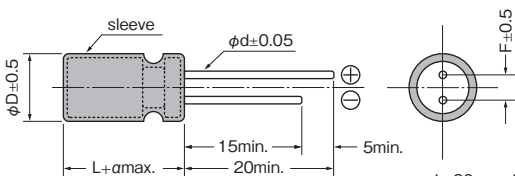
 $\alpha : L < 20 \quad \alpha = 1.5, L \geq 20 \quad \alpha = 2.0$

A pressure relief vent is provided for φD=6.3 or bigger

(Unit : mm)

φD	5	6.3	8	10	12.5	16	18
F	2.0	2.5	3.5	5.0	5.0	7.5	7.5
φd	0.5	0.5	0.6	0.6	0.6	0.8	0.8

Size, Rated Ripple Current

μF \ V	160		200		250		350		400		450	
0.47	5×11	7.0	5×11	8.0	5×11	8.0						
1.0	5×11	15	5×11	16	5×11	18	6.3×11	20				
2.2	6.3×11	22	6.3×11	24	6.3×11	25	8×11.5	28	8×11.5	28		
3.3	6.3×11	28	6.3×11	32	8×11.5	34	8×12.5	36	10×12.5	36		
4.7	6.3×11	39	8×11.5	40	8×11.5	41	10×12.5	47	10×16	47		
10	8×11.5	63	8×12.5	64	10×12.5	66	10×20	70	10×20	70	16×21	70
22	10×12.5	107	10×16	112	10×20	119	12.5×25	123	12.5×25	126	16×25	125
33	10×20	137	10×20	147	12.5×20	154	16×25	158	16×25	161	16×30	154
47	12.5×20	172	12.5×20	175	12.5×25	182	16×30	182	16×30	189	18×35.5	172
68	12.5×20	217	12.5×25	228	16×25	235	16×35.5	242	18×35.5	249		
82	12.5×25	270	16×21	277	16×30	284	18×35.5	294				
100	12.5×25	287	16×25	301	16×35.5	302						
150	16×30	385	16×35.5	403	18×35.5	412						
220	16×35.5	522	18×35.5	532								

Please refer to page 14 for ripple current frequency coefficients.

Upper : ME-FC series (0.47μF to 4.7μF:ME-FC series)

Lower : ME-FD series

Case size: φDL (mm)

 Rated ripple current
mA rms (120Hz, 105°C)

Part number

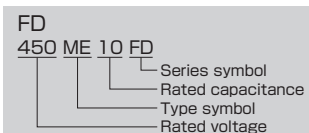
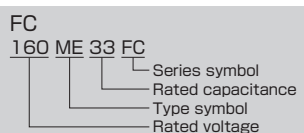

ME-FH Series

105°C, Small, Long Life

High Voltage



- 105°C 10,000 to 12,000hours
- Non solvent proof

Specifications

Items	Condition	Specifications						
Rated voltage (V)	—	160	200	250	350	400	450	
Surge voltage (V)	Room temperature	200	250	300	400	450	500	
Category temperature range (°C)	—	-40 to +105						
Capacitance tolerance (%)	120Hz/20°C	M : ±20						
Dissipation Factor (tan δ)	tanδ (max.) 120Hz/20°C	0.20	0.20	0.20	0.25	0.25	0.25	
Leakage current (LC)	µA/after 2minutes (max.), 20°C	0.02CV +25						
Impedance ratio at low temperature	Based on the value at 120Hz, +20°C	-25°C Z/Z _{20°C}	3	3	3	4	6	6
		-40°C Z/Z _{20°C}	6	6	6	8	10	—
Endurance	105°C rated voltage applied (With the rated ripple current)	Test	φ10 : 10,000hours, φ12.5 to φ18 : 12,000hours					
		△C/C	Within ±20% of the initial value					
		tanδ	Less than 200% of the specified value					
		LC	Less than the specified value					

Dimensions

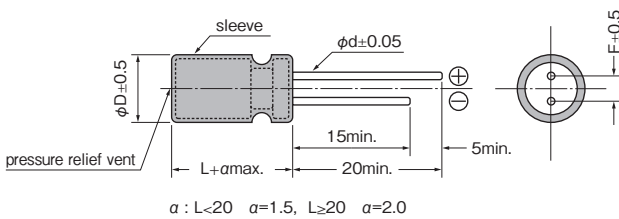

(Unit : mm)

	10	12.5	16	18
φD	10	12.5	16	18
F	5.0	5.0	7.5	7.5
φd	0.6	0.6	0.8	0.8

Size, Rated Ripple Current

µF \ V	160	200	250	350	400	450
4.7					10×12.5	57
6.8					10×16	88
10		10×12.5	105	10×16	106	10×16
22		10×16	173	10×20	184	12.5×20
33	10×16	190	10×20	227	12.5×20	238
47	10×20	270	12.5×20	270	12.5×25	282
68	12.5×20	336	12.5×20	325	16×25	364
82	12.5×20	346	12.5×25	370	16×25	403
100	12.5×25	410	16×25	436	16×31.5	418
150	16×25	500	16×31.5	470	18×31.5	545
220	16×31.5	570	18×31.5	660		

Please refer to page 14 for ripple current frequency coefficients.

Case size: φD×L (mm)

Rated ripple current Arms (120Hz, 105°C)

Part number

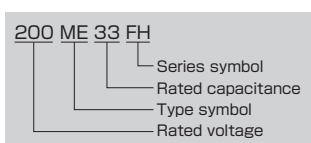

ME-SWN Series

Bi-polar
7mm Height



- 85°C 1,000hours
- Solvent proof(within 3 minutes)

Specifications

Items	Condition	Specifications					
Rated voltage (V)	—	6.3	10	16	25	35	50
Surge voltage (V)	Room temperature	8.0	13	20	32	44	63
Category temperature range (°C)	—	-40 to +85					
Capacitance tolerance (%)	120Hz/20°C	M : ±20					
Dissipation Factor(tan δ)	tanδ (max.) 120Hz/20°C	0.24	0.22	0.20	0.18	0.16	0.16
Leakage current(LC)	μA/after 1minutes (max.), 20°C	0.03CV +6					
Endurance	500hours×2(alternately) 85°C.rated voltage applied (With the rated ripple current)	ΔC/C	Within ±25% of the initial value				
		tanδ	Less than 200% of the specified value				
		LC	Less than the specified value				

Dimensions

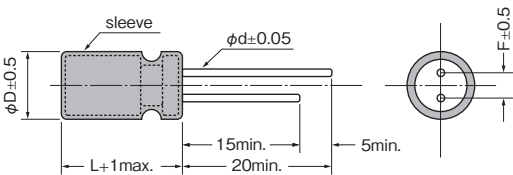

(Unit : mm)

φD	4	5	6.3
F	1.5	2.0	2.5
φd	0.45	0.45	0.45

Size, Rated Ripple Current

μF \ V	6.3		10		16		25		35		50	
1.0											4×7	10
2.2									4×7	10	5×7	15
3.3							4×7	16	5×7	17	5×7	18
4.7							4×7	19	5×7	20	6.3×7	23
10			4×7	17	4×7	25	5×7	28	6.3×7	30	6.3×7	34
22	5×7	31	5×7	35	6.3×7	39	6.3×7	52				
33	5×7	39	6.3×7	43	6.3×7	57						
47	6.3×7	47	6.3×7	59	6.3×7	68						

Please refer to page 14 for ripple current frequency coefficients.

Case size:φDxL(mm)

Rated ripple current
mA Arms(120Hz, 85°C)

Part number

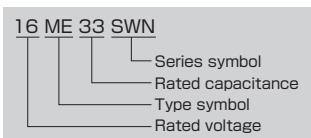

Radial Lead Type
Aluminum Electrolytic Capacitors

- ME-SZ
- ME-SAX
- ME-SWG
- ME-LS
- ME-CZ
- ME-CA
- ME-CX
- ME-AX
- ME-WX
- ME-WA
- ME-WL
- ME-WG
- ME-FX
- ME-FC-FD
- ME-FH
- ME-SWN
- ME-HWN

ME-HWN Series

Bi-polar

Standard



- 85°C 2,000hours
- Solvent proof(within 5 minutes)

Specifications

Items	Condition	Specifications							
Rated voltage (V)	—	6.3	10	16	25	35	50	100	
Surge voltage (V)	Room temperature	8.0	13	20	32	44	63	125	
Category temperature range (°C)	—	-40 to +85							
Capacitance tolerance (%)	120Hz/20°C	M : ±20							
Dissipation Factor(tan δ)	tanδ(max.)120Hz/20°C	0.24	0.20	0.18	0.16	0.14	0.13	0.10	
		Exceeding 1,000μF, +0.02 every 1,000μF							
Leakage current(LC)	μA/after 1minute (max.), 20°C	0.03CV +6							
Impedance ratio at low temperature	Based on the value at 120Hz, +20°C	-25°C Z/Z _{20°C}	4	3	3	2	2	2	2
		-40°C Z/Z _{20°C}	10	8	8	6	4	4	4
Endurance	500hours×4(alternately) 85°C, rated voltage applied (With the rated ripple current)	ΔC/C	Within ±25% of the initial value						
		tanδ	Less than 200% of the specified value						
		LC	Less than the specified value						

Dimensions

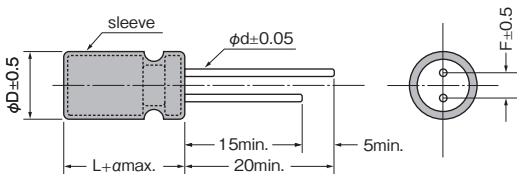

α : L<20 α=1.5, L≥20 α=2.0

A pressure relief vent is provided for φD=6.3 or bigger

(Unit : mm)

φD	5	6.3	8	10	12.5
F	2.0	2.5	3.5	5.0	5.0
φd	0.5	0.5	0.6	0.6	0.6

Size, Rated Ripple Current

μF \ V	6.3	10	16	25	35	50	100
1.0						5×11	10
2.2						5×11	20
3.3						5×11	28
4.7				5×11	25	5×11	30
10			5×11	28	5×11	40	5×11
22		5×11	38	5×11	50	5×11	60
33	5×11	50	5×11	58	5×11	60	6.3×11
47	5×11	60	5×11	70	6.3×11	85	6.3×11
100	6.3×11	120	6.3×11	125	8×11.5	165	8×12.5
220	8×11.5	210	8×12.5	225	10×12.5	260	10×16
330	8×11.5	260	10×12.5	295	10×16	360	10×20
470	10×12.5	330	10×16	390	10×20	420	12.5×20
1000	10×20	560	12.5×20	620	12.5×25	740	
2200	12.5×25	890					

Please refer to page 14 for ripple current frequency coefficients.

Case size: φD×L(mm)

Rated ripple current mArms(120Hz, 85°C)

Part number

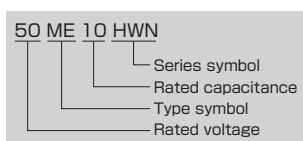

SunCon network expanding around the world

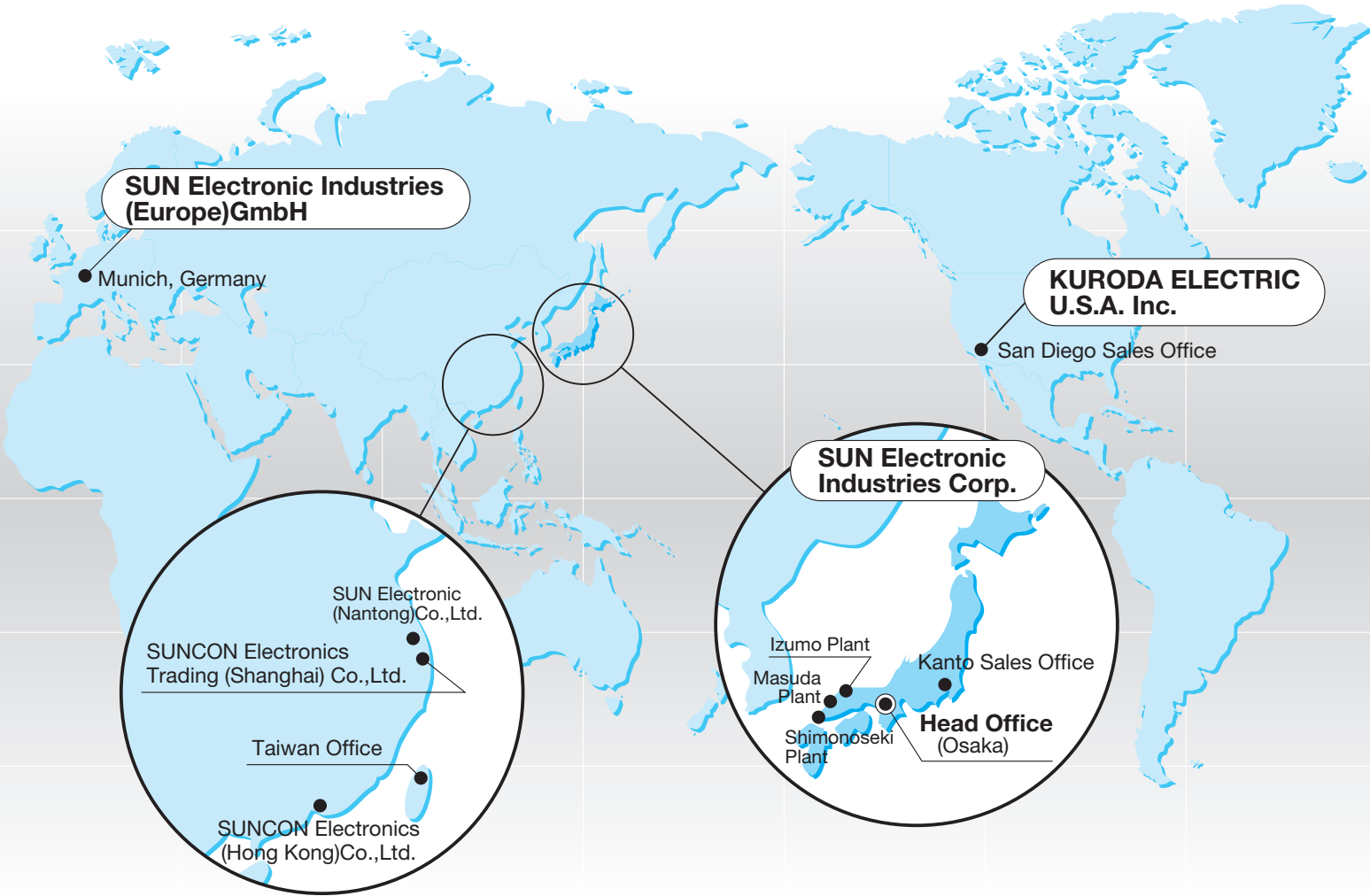

Head Office



Izumo Plant



Masuda Plant



SUN Electronic(Nantong)Co.,Ltd.



 **SUN Electronic Industries Corp.**

<http://www.sunelec.co.jp>

■ **Head Office**

1-1-18, Okayama-higashi, Shijonawate-City, Osaka, Japan 575-8585
Phone:+81-72-876-1423 Fax:+81-72-879-0395

■ **Taiwan Office**

Room302, 3F., No.160, Sec.2, Nanjing E. Rd., Jhongshan District, Taipei City 104, Taiwan
Phone:+886-2-2516-0602 Fax:+886-2-2517-6045

■ **SUNCON Electronics (Hong Kong) Co., Ltd.**

Room2311, Paul Y. Centre, 51 Hung To Road, Kwun Tong, Kowloon, Hong Kong
Phone:+852-2707-0502 Fax:+852-2707-9881

■ **SUNCON Electronics Trading (Shanghai) Co., Ltd.**

Room No.2705,360 changshou Road,Putuo District,Shanghai,China P.C:200060
Phone:+86-21-6259-1750 Fax:+86-21-6259-1791

■ **SUN Electronic Industries (Europe) GmbH**

Hohenlindener strasse 1, 81677 Munich, Germany
Phone:+49-89-91049188

■ **KURODA ELECTRIC U.S.A. Inc.**

19925 Stevens Creek Blvd., Suite100, Cupertino, CA, 95014, USA
Phone:+1-619-661-8288

Any inquiry or purchasing order, please contact the following.

